

**FULING** 富凌变频  
FULING INVERTER

中国专用变频器制造商

Http://www.chinafuling.com

E-mail:fuling@chinafuling.com

# DZB200 INVERTER

## M & J

# USER'S MANUAL



Safety and Cautions

Product Introduction

Mechanical and Electrical Installation

Operation and Display

Function Parameters List

Parameter Description

Fault Diagnosis and Countermeasures

Quality Guarantee

Appendix

说明：  
● 版权所有，禁止向未经授权的经销商转售。  
● 本公司对产品持续升级进行保留，恕不另行通知。

CHINA

**FULING** INVERTER

## Preface

Thank you for choosing DZB 200M&J Series AC Motor Drives.

This manual will be helpful in the installation, parameter setting, troubleshooting, and daily maintenance of the AC motor drives. To guarantee safe operation of the equipment, read the following safety guidelines before connecting power to the AC drives. Keep this operating manual handy and distribute to all users for reference.

### Attention:

- ◆ Always read this manual thoroughly before using DZB series AC Motor Drives.
- ◆ Do not connect or disconnect wires and connectors while power is applied to the circuit.
- ◆ AC input power must be disconnected before any maintenance.
- ◆ There are highly sensitive components on the printed circuit boards. These components are especially sensitive to ESD (electrostatic discharge). **To avoid damage to the drive**, do not touch components or the circuit boards until static control precautions have been taken.
- ◆ To avoid personal injury, do not remove the cover of the AC motor drive until all of the digital keypad "DISPLAY LED" lamps are off. The DC-link capacitor remains charged with a hazardous voltage even after input power is removed.
- ◆ Never connect the main circuit output terminals U, V, and W directly to the AC main circuit power supply as **this will damage the drive**.
- ◆ Grounding the Inverter by **connecting the Earth Ground to the drive ground terminal**.

### Apply scope of the manual :

This manual is for DZB200M & DZB200J Series AC Motor Drive.

Version:2007.9-V1

# Index

---

<b>Chapter 1 Safety and Cautions</b> .....	1
<b>Chapter 2 Product Introduction</b> .....	6
<b>Chapter 3 Mechanical and Electrical Installation</b> .....	8
<b>Chapter 4 Operation and Display</b> .....	17
<b>Chapter 5 Function Parameters List</b> .....	21
<b>Chapter 6 Parameter Description</b> .....	34
<b>F0 Basic Function Parameters</b> .....	34
<b>F1 Motor Parameters</b> .....	42
<b>F2 Input and Output Terminal Function Parameters</b> .....	44
<b>F3 Human Machine Interface Parameters</b> .....	52
<b>F4 Application Function Parameters</b> .....	55
<b>F5 Protection Parameters</b> .....	64
<b>F6 Communication Parameters</b> .....	67
<b>Chapter 7 Fault Diagnosis and Countermeasures</b> .....	71
<b>Chapter 8 Quality Guarantee</b> .....	79
<b>Appendix A Standard Specifications</b> .....	80
<b>Appendix B Dimensions</b> .....	82
<b>Appendix C Accessories List</b> .....	84

## Chapter 1 Safety and Cautions

### Safety Definition

There are two kinds of safety cautions in the manual:

 Operations which are not performed according to the requirements may cause severe hurt or even death.

 Operations which are not performed according to requirements may cause moderate hurt or light hurt or equipment damage.

### 1.1 Safety Cautions

#### 1. Before Installation

 Danger

Do not use the inverter that is damaged or has defect, or there will be danger of injury.

#### 2. During Installation

 Danger

Mount the inverter on incombustible surface like metal, and keep away from flammable substances! Otherwise it may cause fire.

 Note

- ★ When more than two inverters are to be installed in one cabinet, please pay attention to the installation locations to ensure the cooling effect (refer to Chapter 3 Mechanical and Electrical Installation).
- ★ Do not drop the lead wire stub or screw in the inverter, or the inverter may be damaged.

#### 3. Wiring

 Danger

- ★ Only the qualified electrical engineer can perform the wiring, otherwise there will be danger of electric shock.
- ★ A circuit breaker must be installed between the mains and the inverter, otherwise there will be danger of fire.
- ★ Wiring can only be done after the mains input is cut off, otherwise there will be danger of electric shock.
- ★ Please connect the inverter to the ground according to the standard, otherwise there will be danger of electric shock.

 Note

- ★ Do not connect the input terminals with the output terminals (U, V, W), otherwise the inverter may be damaged!
- ★ Ensure the wiring meet the EMC requirements and the local safety standard. The wire size shall be determined according to the manual, otherwise accident may occur!
- ★ Brake resistor must not be connected between the DC bus terminals (+) and (-), otherwise fire may occur!

#### 4. Before Power-on

 Danger

- ★ Please confirm the mains voltage level is consistent with that of the inverter and the input and output wirings are correct, and check if there is any short circuit in peripheral circuit and if the wiring is fixed and fast, otherwise the inverter may be damaged!
- ★ Mount the cover plate properly before power-on the inverter, otherwise there will be danger of electric shock.

 Note

- ★ Dielectric strength test had been done at factory. Therefore, user needs not do this test again, otherwise accident may occur!
- ★ All the peripheral parts shall be connected correctly according to the manual, or accident may occur!

#### 5. After Power-on

 Danger

- ★ Do not open the cover of the inverter after power-on, otherwise there will be danger of electric shock!
- ★ Do not touch the inverter and its circuit with wet hand, otherwise there will be danger of electric shock.
- ★ Do not touch the inverter terminals, otherwise there will be danger of electric shock.
- ★ At power-on, the inverter will perform the security check of the external heavy-current circuit automatically, so at this time please do not touch the terminals U, V and W, or the terminals of motor, otherwise there will be danger of electric shock.

 Note

- ★ If parameter identification is required, please pay attention that the rotating motor may injure people, otherwise accident may occur!
- ★ Do not change the factory settings, otherwise the inverter may be damaged!

## 6. Running

 Danger

- ★ Do not approach the equipment when restart function is enabled, otherwise there will be danger of injury.
- ★ Do not touch the fan and the discharging resistor to check the temperature, otherwise burning may occur!
- ★ Non-professional person shall not measure the signal of a running inverter, otherwise there will be danger of injury or damaging the inverter!

 Note

- ★ Do not let objects fall in a running inverter, otherwise the inverter may be damaged!
- ★ Do not start and stop the inverter by on/off of the contactor, otherwise the inverter may be damaged!

## 7. Maintenance

 Danger

- ★ Please do not repair or maintain the inverter with power on, otherwise there will be danger of electric shock!
- ★ Please repair or maintain the inverter after confirming the charge LED turns off, otherwise there may be human injury caused by the residual voltage of the capacitor!
- ★ Only qualified electrical engineer can repair or maintain the inverter, otherwise there will be danger of human injury or damaging the equipment.

## 1.2 Cautions

### 1. Check the Insulation of the Motor

When the motor is used for the first time, or reused after storing for a long time, or in regular checkup, the user must check the insulation of the motor to prevent the poor insulation of the windings of motor from damaging the inverter. The motor connection must be divided from the inverter during the insulation check. It is recommended to use a 500V Mega-Ohm-Meter to check and the insulation resistance shall not be less than 5MΩ.

### 2. Thermal Protection of Motor

If the rated capacity of the motor selected is not matching that of the inverter, especially when the rated power of the inverter is bigger than that of the motor, make sure to adjust the parameters for motor protection inside the inverter or to install a thermal relay to the motor to guarantee the protection to the motor.

### 3. Running at Frequency Above Rated Frequency

The output frequency of this inverter is 0-600Hz. Please consider the capability of the mechanical devices when the customer needs the inverter to run at the frequency higher than 50Hz.

### 4. Motor Heat and Noise

Since the output voltage of the inverter is in PWM wave with some harmonics, the temperature may rise, the noise and vibration may increase compared with the inverter running at main frequency.

### 5. Pressure-sensitive Device or Capacitor at the Output Side of the Inverter

Because the inverter outputs PWM wave, the capacitor used for improving power factor and pressure-sensitive resistor used for lightening-proof shouldn't be installed at the output side of the inverter, otherwise the inverter may have transient over-current and may be damaged.

### 6. Switches Used at the Input and Output terminal of the Inverter

If the contactor is required to be installed between the inverter and the power supply, it is prohibited to start or stop the inverter with the contactor. If the user has to use the contactor to start and stop the inverter, the interval between the start and stop shall be less than one hour. Frequent charging and discharging may reduce the life of the capacitor. If the switches like contactors are connected between the output terminal and the motor, make sure to start and stop the inverter when the inverter has no output, otherwise the modules in the inverter may be damaged.

### 7. Usage Outside the Range of Rated Voltage

The DZB series inverter shall not be used out of the specified range of operation voltage, otherwise the internal components of the inverter may be damaged. If needed, please use corresponding voltage regulation device to change the voltage.

### 8. 3-phase Input Modified Into 2-phase Input

The modification of DZB series inverter from 3-phase input to 2-phase input is not allowed, or fault may occur.

### 9. Lightning Strike Protection

There are lightning protection devices inside the inverter. But the user should install other lightning protection device at the front end of the inverter if lightning strike occurs frequently.

### 10. Altitude and Deration

When the altitude is higher than 1000m, the cooling effect of inverter is deteriorated because of the rarefaction of air, the deration must be used and please consult our company for detailed technical support.

**11. Special Usages**

The user can consult our company if he wants to use another method instead of the recommended connecting method provided in the manual, such as shared DC bus.

**12. Cautions for Scrap of Inverter**

The electrolytic capacitors in the main circuits and PCB may explode when they are burned and poisonous gas may be generated when the plastic parts are burned. Please dispose the inverter as industrial rubbish.

**13. About Applicable Motor**

- 1) The standard motor used is the 4-pole squirrel cage asynchronous induction motor. If other kind of motor is used, please be sure to select the applicable inverter according to the rated current of the motor, and please consult us if the user wants the inverter to drive the permanent magnetic synchronized motor.
- 2) The cooling fan of non-variable frequency motor is connected to the rotor in the same bearing, so the cooling effect is weakened if the speed is low, therefore use the variable-frequency motor or install a cooling fan in the overheat condition the motor.
- 3) The inverter has already been configured with the standard parameters for applicable motor, please be sure to modify the default values or perform the motor parameter identification according to the actual conditions, otherwise the operation effect or protection performance may be reduced.
- 4) Short-circuit in the cable or motor may cause the inverter alarm or even damage the inverter.

Therefore, please conduct the insulation short-circuit test to the cable and the motor installed for the first time. The short-circuit test shall also be carried out in routine maintenance. Pay attention that the inverter shall be separated from the unit during such test.

## Chapter 2 Product Introduction

The purpose of this chapter is to provide specific, yet simple information to **unpack, install** the AC drive.

This chapter contains information on the following:

- 2.1 Receiving, Transportation, and Storage**
- 2.2 Nameplate Information**

### 2.1 Receiving, Storage and Transportation

The AC motor drive has gone through rigorous quality control tests at the factory before shipment. After receiving the AC drive, check for the following.

- **Receiving**

1. Check to make sure that the package includes an AC drive, the User Manual, dust covers and rubber bushings.
2. Inspect the unit to insure it was not damaged during shipment.
3. Make sure that the part number indicated on the name plate corresponds with the part number of your order.

- **Storage**

The AC Drive should be kept in the shipping carton before installation. In order to retain the warranty coverage, the AC drive should be stored properly when it is not to be used for an extended period of time.

Some storage suggestions are:

1. Store in a clean, dry location.
2. Store within an ambient temperature range of -20° C to +65° C.
3. If possible, store in an air-conditioned environment where the relative humidity is less than 95%, non-condensing.
4. Do not store the AC drive in places where it could be exposed to corrosive gases.
5. Please store the AC drive on a shelf or on a stable surface.

- **Transportation**

Temperature: -25° C to +70° C; R.H.: 5% to 95%;

Air Pressure: 70kPa to 106kPa.

## 2.2 Nameplate Information

Nameplate

MODEL: DZB200M0015L2B

INPUT: 3PH 220V 50/60Hz

OUTPUT: 3PH 0~220V 0~600Hz

POWER: 1.5KW 3.7A

S/N:



082M214B0701888

TAIZHOU FULING ELECTROMOTOR CO.,LTD

Description of AC Motor Drive Model:

**DZB200 M 0015 L 2 B**

Function level code: A -braking unit inside

B -non braking unit

Input voltage: 2-220V 4-400V 6-660V

Freq. Range: L: 0-600.0Hz

Applicable motor capacity: 0015为1.5KW

Series: M:Mini Model

J :Simpl Model

Series name: DZB200Series

Description of Serial Number:

**07 01 8888**

Production number

Production month

Production year

## Chapter 3 Mechanical and Electrical Installation

### 3.1 Mechanical Installation

#### 1. Installation Environment

- 1) Ambient temperature: Ambient temperature influences the inverter life greatly, so it should be within the range of -10°C~50°C.
- 2) Mount the inverter in a flame retardant surface and the clearance around the inverter shall be enough because the inverter will generate lots of heat during running, besides mount the inverter on the base vertically with screws.
- 3) Mount in the location where vibration is less than 0.6G; the inverter shall be far away from impacting lath.
- 4) Please do not install the inverter in the place with direct sunlight, high humidity and water.
- 5) Mount the inverter in the location free of corrosive gas, explosive gas or combustible gas.
- 6) Mount the inverter in the location free of oil dirt, dust, and metal powder.

#### 2. Installation Location

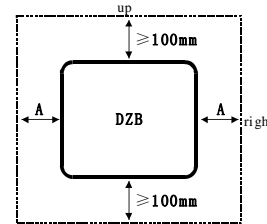

Note: No need to consider the dimension A for inverter of 2kW or below. A shall be bigger than 50mm for the inverter of 2.2kW or above

Installation of single inverter

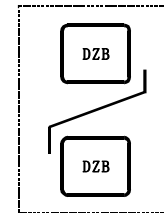

Note: Install an airflow-guidance plate for the up and down installation of inverters.

Up and down installation of inverters

Fig.3-1 DZB Series Inverter Installation Location

The user shall focus on the heat dissipation issues when installing the inverter, and pay attention to the following points:

- 1) Install the inverter vertically so that the heat may be expelled from the top, but do not install the inverter upside down. When two Variable Speed Drives are mounted up and down, an air flow diverting plate should be fixed in between as shown in Fig.3-1.
- 2) Installation space is shown in Fig.3-1 so as to ensure the heat dissipation space, but consider the heat dissipation of other components when placing the inverter.
- 3) The installation bracket must be flame retardant.
- 4) Install the heat sink outside of the cabinet if the inverter is installed in the area with metal powder. And in this case, the space inside the sealing cabinet shall be big enough.

### 3.2 Electrical Installation

#### Basic Wiring Diagram

Inverter wiring section includes main circuit and control circuit. User can open the cover, looking at the main circuit and control circuit terminals. User should be wiring follow the diagram below.

1) DZB200M series inverter standard wiring diagram. If only using the panel operate the inverter, just wiring the main circuit.

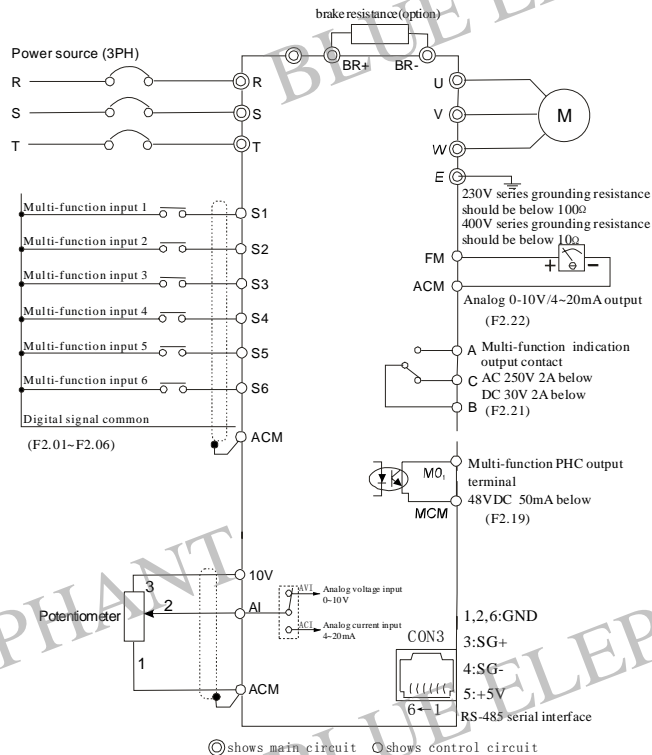

Fig.3-2 Basic Wiring Diagram

2) DZB200J series inverter standard wiring diagram. If only using the panel operate the inverter, just wiring the main circuit.

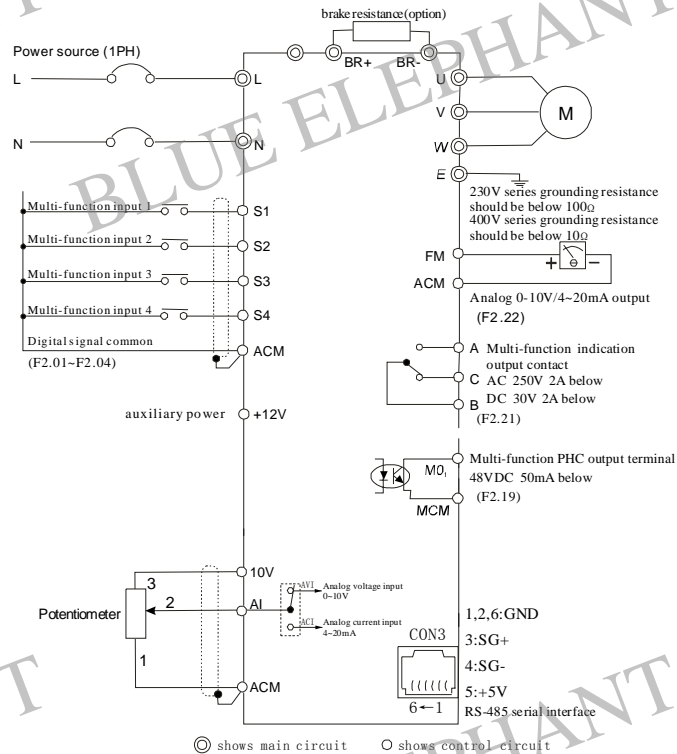

Fig.3-2 200J Basic Wiring Diagram



● Main Circuit Wiring

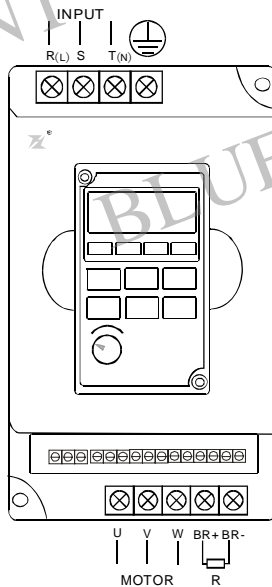

Fig.3-4 Terminal Diagram

**Danger**

- ★ Wiring can only be done after the mains input is cut off, otherwise there will be danger of electric shock!
- ★ Only qualified and trained engineer can perform the wiring, otherwise there will be danger of electric shock!
- ★ Grounding cable must be grounded, otherwise there will be danger of electric shock or fire!

**Danger**

- ★ Please confirm the mains voltage level is same with that of the inverter, otherwise the inverter may be damaged!
- ★ Make sure the ratings of the driven motor are in compliance with the inverter, otherwise the motor may be damaged or the inverter may be in protection status!
- ★ Do not confuse the input terminals with the output terminals (U, V, W), otherwise there will be danger of damaging the inverter!
- ★ Brake resistor cannot be connected between the DC bus terminals (+) and (-), otherwise fire may occur!

1) Main Circuit Terminals of Inverter

Terminals	Description
R、S、T(L、N)	AC input line terminals
U、V、W	Motor connection
BR+、BR-	Connection for the braking resistor (option)
E	Ground

2) Notes on Wiring

A. Input power supply L and N or R, S and T:

There is no phase-ratation requirement for the input of inverter.

C. Brake resistor terminals of (BR+)、(BR-) :

The brake resistor terminal is effective only for the inverter of 15kW or below and has a built-in brake unit. Select the recommended resistor with the cable length of less than 5m, otherwise the inverter may burn or be damaged.

D. Inverter output U, V and W:

Inverter output terminals cannot connect to capacitors or surge snub devices, otherwise the inverter may be in protective status or damaged.

If the cables between the motor and the inverter are too long, electrical resonance may occur due to the distributed capacitance, which may result in damaging the motor insulation or big leakage current, so if the cable length is longer than 100m, AC reactor must be installed.

**E. Grounding Terminal:**

Grounding Terminal must be connected to earth reliably and the grounding resistance shall be less than 5Ω, otherwise the equipment may work abnormally or be damaged. Do not share the PE and neutral line of the mains supply.

**5. Control Terminals and Wiring**

1) Layout of Control Terminals(Fig.3-4, Fig3-5):

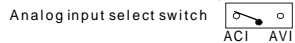
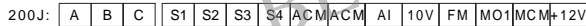
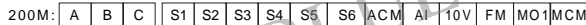

2) Function of Control Terminals:

Terminal	Function	
MO <sub>1</sub> -MCM	Multi-function PHC output 1	
A-B	Multi-function indication output contact	Refer to F2.19~F2.21
B-C	Multi-function indication output contact	
S1-DCM	Multi-function input 1	Refer to F2.01~F2.06
S2-DCM	Multi-function input 2	
S3-DCM	Multi-function input 3	
S4-DCM	Multi-function input 4	
S5-DCM	Multi-function input 5	
S6-DCM	Multi-function input 6	
+12V	Auxiliary control power source	
AVI-ACM	Analog signal input	0~10 V (Max. output freq.) Input
ACI-ACM		4~20mA /0~10V Input
FM-ACM	Analog signal output	4~20mA /0~10V Output Refer to F2.22
10V-ACM	Power supply for speed setting	+10 V (20 mA max. output current)

3) Notes on Control Terminals:

A) Analog input terminal:

Since the weak analog voltage signal is easily disturbed by external disturbance source, shielded cable shall be used and the cable shall be as short as possible and the length shall not exceed 20m, as shown in the figure 3-6:

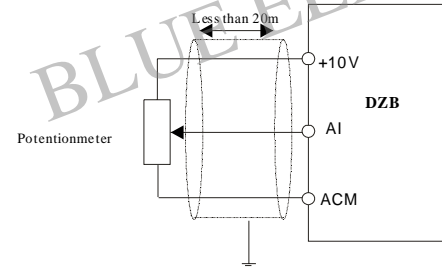

Fig. 3-6 Analog Input Terminal of DZB Series Inverter

If the analog signal is severely disturbed, filter capacitor or ferrite core shall be installed at the analog signal source as shown in the Fig. 3-7:

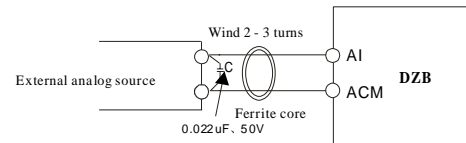

Fig. 3-7 Analog Input Terminal With Filter devices

B) Digital input terminal:

The inverter judges the ON/OFF status of these terminals by receiving the digital signal. Hence, all the external contactors are those with high reliability of weak signal conduction.

If the open collector is employed to provide ON/OFF signal for the inverter digital input terminal, then it shall be considered that there is error operation caused by power supply interference.

It is recommended to use contact control mode.

C) Digital Output terminal:

When digital output terminal drives a relay, the coil of the relay shall be installed a snubbing diode, otherwise the DC 24V power supply may be damaged.

**Note:** Pay attention to the polarity of the diode as shown in the figure 3-8. Otherwise if the digital output terminal has output, the DC24V power supply will be damaged.

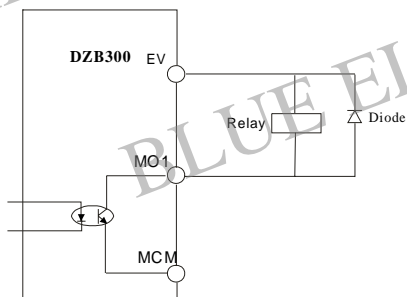

Fig. 3-8 Digital Input Terminal of DZB Series Inverter

## 6. EMC Issues

### 6.1 Influence of Harmonics

- 1) The high frequency harmonics of mains supply will influence the rectifying circuit of the inverter. The harmonics will heat the rectifying circuit and even damage the circuit. So, it is recommended to install the filtering device in the environment where the power quality is poor.
- 2) Since the inverter output has high frequency harmonics, the output cannot be installed with capacitor or surge suppressing devices because the capacitor and surge suppressing device may resonate the circuit and damage the equipment.

### 6.2 EMI

- 1) Two kinds of EMI, one is the EMI around the inverter and disturbs the inverter. This kind of EMI is weak, besides the inverter has been designed with strong immunity. Another is the EMI from the inverter that may influence the equipment around the inverter. The inverter itself is a disturbance source because it outputs PWM wave through high carrier frequency, so solving the EMI issue is mainly to reduce the EMI of inverter.

Methods:

- A) Inverter and other equipment shall be well grounded and the grounding resistance shall be less than 5ohm.
- B) Inverter's power cables shall be vertical instead of parallel with the control cables.
- C) For the application with strong disturbance, the power cables from the motor to the inverter shall be shielded and the shielding layer shall be grounded.
- D) The cables of disturbed equipment shall be twisted shielded cables and the shielding layer shall be grounded.

- 2) Reducing the disturbance to the inverter from other equipment

The relay, contactor or electronic -magnetic braking device will disturb the inverter.

Take the following actions to solve this issue:

- A) Install surge suppressing devices to the disturbing device
- B) Install filter to the input of the inverter
- C) Inverter's control cables shall be shielded and the shielding layer shall be grounded

### 3) Method to reduce the disturbance from the inverter to the equipment

Two kinds of noises, one is the radiation from the inverter itself, and another is the radiation from the cable between the inverter and the motor. These two kinds of radiations induce the cables of the equipment and make the equipment work abnormally. Following method can be used:

- A) If the measuring meters, radio equipment and sensors and their signal cables are installed in a cabinet together with the drive, these equipment cables will be easily disturbed. Take the actions below to solve the problem: The equipment and the signal cables should be as far away from the inverter as possible; Signal cables and power cables shall not be routed in parallel or bound together; The signal and power cables should be shielded; Install radio noise filter and linear noise filter at the input and output sides of the inverter
- B) If the external equipment shares a same AC supply with the inverter, and the above cannot eliminate the disturbance, then the user should install a linear filter or a radio noise filter.
- C) Ground the external equipment and eliminate the disturbance of the leakage current from the inverter's grounding cable.

### 6.3 Leakage current

The inverter has two kinds of leakage current, one is the grounding leakage current and another is the leakage current between the lines:

- 1) Grounding leakage current:

The distributed capacitance exists between the cables and the ground, and the bigger the capacitance and the bigger the leakage current, so the motor cables should be as short as possible. Besides, the bigger the carrier frequency is, the bigger the leakage current is, so the user can also reduce the carrier wave frequency, but the motor noise may increase. Installing reactor can also reduce the leakage current. The leakage current is increased with the increase of the circuit current, so the leakage current is big if the motor power is big.

- 2) Leakage current between lines:

The distributed capacitance exists in the inverter's output cables, and resonance may occur if high frequency harmonics exist in the current, thus the leakage current occurs, which may result in the wrong action of relay.

The method to solve this issue is to reduce the carrier frequency or install the output reactor. It is recommended to use inverter's protection function instead of a thermal relay to protect the motor before using the inverter.

## Chapter 4 Digital Keypad Operation

### 4.1 Description of the Digital Keypad

#### ● Digital Keypad Parts and Functions

This digital keypad module includes two parts: display panel and a keypad. The display panel allows the user to program the AC drive, as well as view the different operating parameters. The keypad is the user interface to the AC motor drive. Refer to the following figure for a description of the different parts.

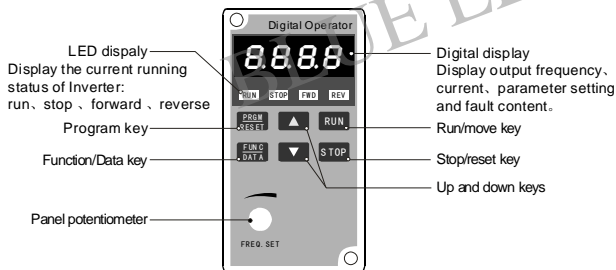

Fig.4-1 Operation Panel Schematic Diagram

Key	Description
	<b>Program / Reset</b> First-stage menu entry or exit.
	<b>Function / Data</b> Displays information on the AC drive status such as the reference frequency, output frequency, or output current in the normal mode. While the drive is in the Program Mode, press this key once to display the current parameters. After changing the parameters, press this key again to store the new parameters.
	<b>Run</b> Used to start the AC drive operation. This key has no effect when the drive is set to terminal run.
	<b>Stop</b> Used to stop the AC drive operation. If the AC drive has stopped due to a fault, press this button to reset the drive.
	<b>Up / Down</b> Press the "Up" or "Down" button to change parameter settings. These keys may also be used to scroll through different operating values or parameters.

#### ● Explanation of Screen Display

##### 1. Explanation of Displayed Messages on Running status (refer to F3.05):

Displayed Symbol	Displayed Message	Operation
H	Setting frequency	Press " " key
P	Running frequency	Press " " key
C	Output current	Press " " key
d	Output voltage	Press " " key
n	Running speed	Press " " key
f	Actual value of delay time	Press " " key
r	Setting of delay time	Press " " key
U	DC bus voltage	Press " " key
R	PID setpoint	Press " " key
b	PID feedback	Press " " key
v	VI value	Press " " key
c	CI value	Press " " key
B	Current segment of multi-speed control	Press " " key

##### 2. Explanation of Displayed Messages on Stop status (refer to F3.06):

Displayed Symbol	Displayed Message	Operation
H	Setting frequency	Press " " key
U	DC bus voltage	Press " " key
I	Input terminal status	Press " " key
O	Output terminal status	Press " " key
R	PID setpoint	Press " " key
b	PID feedback	Press " " key
v	VI value	Press " " key
c	CI value	Press " " key
B	Current segment of multi-speed control	Press " " key

#### 4.2 Modify and Check the Function Codes

DZB200 series inverters' operation panel uses 3-level menu to conduct parameter settings.

3-level menu: function parameter group (first level) → function code (second level) → setting of function code (third level). Operation procedure is shown in Fig. 4-2.

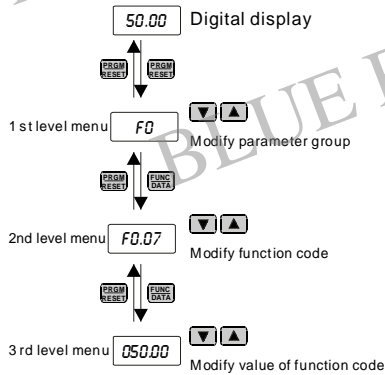

Fig. 4-2 Operation Procedures for 3-level Menu

**Note:** When operating 3-level menu, pressing PRG or DATA can return to second level menu. The difference is: pressing DATA will save the parameters and return to second level menu and then shift to the next function code, while pressing PRG will return to second level menu without saving the parameters.

Example: Change the setting of F1.02 from 10.00Hz to 15.00Hz. (Bold means flash bit.)

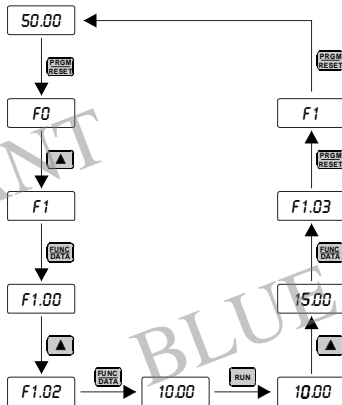

Fig. 4-3 Example for Parameter Changing

In third level menu, if the parameter has no flash bit, it means the function code cannot be changed and the possible reasons are:

- 1) This parameter of this function code cannot be changed, such as the actually detected parameter and running record parameter.
- 2) This function code cannot be changed in operating status and can only be changed when the inverter is stopped.

#### 4.3 How to View Status Parameters

When DZB Series inverter is in the stop or running status, several status parameter of the inverter can be displayed on the LED numeric tube. Pressing the key DATA can display the stop or running status parameters. There are nine stop status parameters to be displayed in the stop status, Setting frequency, DC bus voltage, Input terminal status, Output terminal status, PID setpoint, PID feedback, VI value, CI value, Current segment of multi-speed control.

DZB Series inverter has fifteen running status parameters to be displayed in the running status, Setting frequency, Running frequency, Output current, Output voltage, Running speed, Actual value of delay time, Setting of delay time, DC bus voltage, PID setpoint, PID feedback, Input terminal status, Output terminal status, VI value, CI value, Current segment of multi-speed control.

If the inverter is powered on again after power-off, the parameters displayed are defaulted as those selected before the power-off.

#### 4.4 Password Setting

DZB200 inverter provides password protection for users. When F3.00 is not zero, that is the user password, and the password protection function is valid once exiting the function code editing status. If the user presses PRG again, the inverter shall display "-----", and the user can only enter the menu after inputting the user password. Otherwise, the user cannot enter.

If the user wants to cancel the password protection function, F3.00 should be set 0.

## Chapter 5 Function parameters list

DZB200series inverter function parameters, which are grouped by functions, have F0-F04 total 7 groups. Each function group includes a number of function codes, which adopts three-stage menu, for instance, "F4.08" means the 8th function code of F4th function.

For the convenience of setting function code by using operation panel, the function group number is corresponding to Stage 1 menu, the function code is corresponding to Stage 2 menu and the function code parameter is corresponding to Stage 3 menu.

1. The column of function table is described as follows:

The 1st column "Function Code" is the function parameter group and parameter code.

The 2nd column "Name" is the complete name of the function parameter.

The 3rd column "Setting Range" is the effective setting value range of the function parameter, shown on the operation panel LCD.

The 4th "Default" is the original factory setting value of this function parameter.

The 5th "Modification" is the modification performance of the function parameter (i.e. whether or not it is permitted to modify and the modification conditions), explained as follows,

"※": indicates that the setting value of this parameter can be modified when the inverter is either in stop or operating status;

"●": means that the setting value of this parameter cannot be modified when the inverter is in operating status;

"\*\*\*": means that this parameter is a test value which cannot be modified.

"##": means that this parameter only can be modified by manufacturer.

(Inverter has done the automatic detection restriction to the modification performance of each parameter, helping user to prevent mis-modification.)

The 6th column "Serial No" is the number of function code at the storage inside.

2. "Default" indicates the value of the function code after it is refreshed while doing the manipulation of restoring the factory parameters; but the actually detected parameters or record values cannot be refreshed.

3. In order to effectively protect the parameters, the inverter provides the cryptoguard for the function code. After the user's password is set up (i.e. user's password F3.00 parameter is not 0), when the user press PRG button to enter function code edit status, the system first enters the user's password verification status, displaying "----", and the operator must input correctly the user's password, otherwise it is impossible to enter. At the state that the cryptoguard is not locked, the user's password can be modified at any time, and the one finally input will be the user's password. If F3.00 is set as 0, the user's password can be cancelled; when the power is on, if F3.00 is not 0, parameters are protected by password.

4. When modify parameter using serial communication, usage of user password also abide above principle.

Function Code	Name	Setting Range	Default Value	Modification	Serial No
<b>F0 Basic Function Parameters</b>					
F0.00	Control mode	1: V/F control	1	●	0.
F0.01	Running Command source selection	0: Keyboard	0	●	1.
		1: Terminal			
		2: 485 Communication			
F0.02	Keyboard and terminal UP/DOWN setting	0: Valid, and inverter memorize when power down	0	※	2.
		1: Valid, and inverter does not memorize when power down			
		2: Invalid			
F0.03	Frequency command Selection	0: Keyboard	0	※	3.
		1: Panle potentiometer VI			
		2: External terminal AI			
		3: Reserved			
		4: Multi-speed			
		5: PID control			
6: 485 Communication					
F0.04	Maximum output frequency	10.00~600.00Hz	50.00Hz	●	4.
F0.05	Upper limit frequency	F0.06~F0.04	50.00Hz	※	5.
F0.06	Lower limit frequency	0.00 Hz~F0.05	0.00Hz	※	6.
F0.07	Keyboard frequency setting	0.00 Hz~F0.04	50.00Hz	※	7.
F0.08	ACCEL time 1	0.1~360.0s	10.0s	※	8.
F0.09	DECEL time 1	0.1~360.0s	10.0s	※	9.
F0.10	Operation direction selection	0: Operating at default direction	2	●	10.
		1: Operating at reverse direction			
		2: NO inverse operating			
F0.11	Carrier frequency setting	1.0~15.0kHz	Set by model	※	11.
F0.12	Functional parameters restoration	0: NO operation	0	●	12.
		1: Restore default value			
		2: Delete failure records			
F0.13	AVR selection	0: Invalid	1	※	13.
		1: Valid all the time			
		2: Invalid during deceleration			

Function Code	Name	Setting Range	Default Value	Modification	Serial No
F0.14	Start Mode	0: Direct start	0	●	14.
		1: DC braking first and then start			
		2: Running speed pick-up and then start			
F0.15	Start frequency	0.5~99.99Hz	0.50Hz	※	15.
F0.16	Hold time of start frequency	0.0~50.0s	0.0s	※	16.
F0.17	Braking current before starting	0.0~150.0%	0.0%	※	17.
F0.18	Braking time before starting	0.0~50.0s	0.0s	※	18.
F0.19	Stop Mode	0: DECEL Stop	0	※	19.
		1: Free run Stop			
F0.20	Beginning Frequency of braking	0.00~99.99Hz	0.0Hz	※	20.
F0.21	Waiting time of braking	0.0~50.0s	0.0s	※	21.
F0.22	DC braking current	0.0~150.0%	0.0%	※	22.
F0.23	DC braking time	0.0~50.0s	0.0s	※	23.
F0.24	Dead time between forward and reverse	0.0~360.0s	0.0s	※	24.
F0.25	Terminal command protection when power on	0: Terminal command invalid when power on	0	※	25.
		1: Terminal command valid when power on			
<b>F1 Motor Parameters</b>					
F1.00	Reserved				26.
F1.01	Motor rated power	0.4~55.0kW	Set by model	●	27.
F1.02	Motor rated frequency	0.01Hz~F0.04	50.00Hz	●	28.
F1.03	Motor rated speed	0~9999rpm	Set by model	●	29.
F1.04	Motor rated voltage	0~460V	Set by model	●	30.
F1.05	Motor rated current	0.1~100.0A	Set by model	●	31.
F1.06	Motor stator resistance	0.001~9.999Ω	Set by model	※	32.
F1.07	Motor rotor resistance	0.001~99.99Ω	Set by model	※	33.
F1.08	Motor stator/rotor inductance	0.1~999.9mH	Set by model	※	34.

Function Code	Name	Setting Range	Default Value	Modification	Serial No
F1.09	Mutual inductance of motor stator/rotor	0.1~999.9mH	Set by model	※	35.
F1.10	No-load current	0.01~99.99A	Set by model	※	36.
F1.11	Reserved				37.
F1.12	Speed loop proportional gain1	0~100	30	※	38.
F1.13	Speed loop integral time 1	0.01~10.00s	0.50s	※	39.
F1.14	Switching low point frequency	0.00Hz~F1.17	5.0Hz	※	40.
F1.15	Speed loop proportional gain 2	0~100	25	※	41.
F1.16	Speed loop integral time 2	0.01~10.00s	1.00s	※	42.
F1.17	Switching high point frequency	F1.14~99.99Hz	10.0Hz	※	43.
F1.18	VC slip compensating factor	50%~200%	100%	※	44.
F1.19	Upper torque limit setting (inverter rated current)	0.0~200.0%	160.0%	※	45.
F1.20	V/F curve setting	0: Linear V/F curve	0	●	46.
		1: square torque V/F curve			
F1.21	Torque boost	0.0%: (auto) 0.1%~30.0%	0	※	47.
F1.22	Torque boost cut-off (relative to motor rated frequency)	0.0%~50.0%	20.0%	●	48.
F1.23	V/F slip compensation limit	0.0~200.0%	100%	※	49.
F1.24	Energy Conservation Selection	0:No Operation	0	※	50.
		1:Energy Conservation			
<b>F2 Input and Output Terminal Function Parameters</b>					
F2.00	On-off signal filter times	1~10	5	※	51.
F2.01	S1 Terminal Function Selection	0:No Function	1	●	52.
		1:Forward			
F2.02	S2 Terminal Function Selection	2:Reverse	2	●	53.
		3:three-wire control			
F2.03	S3 Terminal Function Selection	4:Forward Jogging	4	●	54.
		5:Reverse Jogging			
F2.04	S4 Terminal Function Selection	7	7	●	55.

Function Code	Name	Setting Range	Default Value	Modification	Serial No
F2.05	S5 Terminal Function Selection	6:Free run stop	12	●	56.
F2.06	S6 Terminal Function Selection	7:Failure reset	13	●	57.
		8:External fault input			
		9:Frequency setting(UP)			
		10:Frequency setting(DOWN)			
		11:Frequency up/down setting clear			
		12:Multi-Speed Terminal 1			
		13:Multi-Speed Terminal 2			
		14:Multi-Speed Terminal 3			
		15:ACCEL/DECEL Time selection			
		16:PID control pause			
		17:Traverse pause at current frequency			
		18:Traverse reset			
		19:ACCEL/DECEL forbid			
		20:Reserved			
		21:External accel terminal			
		22:External decel terminal			
		23:Delay time setting (up)			
		24:Delay time setting (down)			
25:Programme running reset					
26:Programme running invalid					
F2.07	Terminal control mode	0: two-wire control 1	0	●	58.
		1: two-wire control 2			
		2: three-wire control 1			
		3: three-wire control 2			
F2.08	UP/DOWN frequency increment variable rate	0.01~99.99Hz/s	0.50Hz/s	※	59.
F2.09	V1 lower limit	0.0V~10.0V	0.0V	※	60.
F2.10	V1 lower limit corresponding setting	-100.0%~100.0%	0.0%	※	61.
F2.11	V1 upper limit	0.0V~10.0V	10.0V	※	62.
F2.12	V1 upper limit corresponding setting	-100.0%~100.0%	100.0%	※	63.
F2.13	V1 input filtering time	0.0s~10.0s	0.1s	※	64.

Function Code	Name	Setting Range	Default Value	Modification	Serial No					
F2.14	A1 lower limit	0.0V~10.0V	0.0V	※	65.					
F2.15	A1 lower limit corresponding setting	-100.0%~100.0%	0.0%	※	66.					
F2.16	A1 upper limit	0.0V~10.0V	10.0V	※	67.					
F2.17	A1 upper limit corresponding setting	-100.0%~100.0%	100.0%	※	68.					
F2.18	A1 input filtering time	0.0s~10.0s	0.1s	※	69.					
F2.19	M0 output selection	0:NO output	1	※	70.					
F2.20	Reserved	1: Frequency reaches			71.					
F2.21	Relay output selection	2: FDT output	3	※	72.					
		3: Fault output								
		4: Motor running forward								
		5: Motor running reverse								
		6: Null speed operating								
		7: Upper limit frequency reaches								
		8: Lower limit frequency reaches								
		9~10: Reserved								
		11: High pressure reaches detection(NC)								
		12: Low pressure reaches detection(NC)								
		13: High pressure reaches detection(NO)								
		14: Low pressure reaches detection(NO)								
		15: Sleeping alarms indication								
		16: No water alarms indication								
		17: No zero speed								
		18: Running								
		F2.22				FM Analog output selection	0: Setting frequency	0	※	73.
							1: Running frequency			
2: Output current										
3: Output voltage										
4: Running speed										
5: Output power										
6: Output torque										
7: V1 input value										



Function Code	Name	Setting Range	Default Value	Modification	Serial No	
F2.23	AO Lower limit	8: AI input value	0.0%	※	74.	
		9~10: Reserved				
F2.24	Lower limit corresponding AO output	0.0V~10.0V	0.0V	※	75.	
F2.25	AO Upper limit	0.0%~100.0%	100.0%	※	76.	
F2.26	Upper limit corresponding AO output	0.0V~10.0V	10.0V	※	77.	
<b>F3 Human Machine Interface Parameters</b>						
F3.00	User password	0~9999	0	※	78.	
F3.01	Reserved				79.	
F3.02	Reserved				80.	
F3.03	STOP function option	0: Keypad control valid	0	※	81.	
		1: Keypad and terminal control valid				
		2: Keypad and communication control valid				
		3: All control modes valid				
F3.04	Keypad display option	0: external keyboard preferential ENB	0	※	82.	
		1: Local and external keyboard simultaneous display, only external key-press is valid.				
		2: Local panel and external keyboard simultaneous display, only Local key-press is valid.				
		3: Local and external keyboard simultaneous display, and all key-presses are valid (both are OR logical relation)				
F3.05	operation status display parameter option	Displayed Message	Code	255	※	83.
		0:Setting frequency	1			
		1:Running frequency	2			
		2:Output current	4			
		3:Output voltage	8			
		4:Running speed	16			
		5:Actual delay time	32			
		6:Setting delay time	64			

Function Code	Name	Setting Range	Default Value	Modification	Serial No					
		7:DC bus voltage	128							
		8:PID setpoint	256							
		9:PID feedback	512							
		10:Reserved								
		11:Reserved								
		12:VI value	4096							
		13:AI value	8192							
		14:Current segment of multi-speed control	16384							
		F3.06	Stop status display parameter option			Setting frequency	1	255	※	84.
						DC bus voltage	2			
						Input terminal status	4			
						Output terminal status	8			
						PID setpoint	16			
						PID feedback	32			
VI value	64									
AI value	128									
Current segment of multi-speed control	256									
Actual delay time	512									
Setting delay time	1024									
F3.07	operation status display preferential option	0-14 (0:invalid)	0	※	85.					
F3.08	IGBT module temperature	0~100.0℃		**	86.					
F3.09	Software version			**	87.					
F3.10	Accumulative operating time	0~9999h	0	**	88.					
F3.11	The fault before previous fault type	0: No fault		**	89.					
		1:IGBT U phase protection(E009)								
F3.12	Previous fault type	2:IGBT V phase protection(E019)		**	90.					
F3.13	Current fault type	3:IGBT W phase protection(E029)		**	91.					
		4:Acceleration over-current(E004)								
		5:Deceleration over-current(E005)								
		6:Constant speed over-current (E006)								

Function Code	Name	Setting Range	Default Value	Modification	Serial No
		7:Acceleration over-voltage(E002)			
		8:Deceleration over-voltage(E00A)			
		9:Constant speed over-voltage (E003)			
		10:Bus under-voltage fault (E001)			
		11:Motor overload(E007)			
		12:Inverter overload(E008)			
		13:Input side phase failure(E012)			
		14:Output side phase failure(E013)			
		15:Diode module overheat fault (E00E)			
		16:IGBT module overheat fault (E01E)			
		17:External fault(E017)			
		18:Communication fault(E018)			
		19:Current detect error(E015)			
		20:Motor self-learning error(E016)			
		21:EEPROM operation error (E00F)			
		22:PID feedback disconnect error (E02E)			
		23:Braking unit error (E01A)			
		24:Reserved			
F3.14	Operating frequency at current fault		0.00Hz	**	92.
F3.15	Output amperage at current fault		0.0A	**	93.
F3.16	Bus voltage at current fault		0.0V	**	94.
F3.17	Setting delay time	0~9999s	0	※	95.
F3.18	Setting unit of delay time	0~3	0	※	96.
<b>F4 Application Function Parameters</b>					
F4.00	ACCEL Time 2	0.1~360.0s	10.0s	※	97.
F4.01	DECEL Time 2	0.1~360.0s	10.0s	※	98.
F4.02	Jogging frequency	0.00~F0.04	5.00Hz	※	99.
F4.03	Jogging ACCEL time	0.1~360.0s	10.0s	※	100.
F4.04	Jogging DECEL time	0.1~360.0s	10.0s	※	101.

Function Code	Name	Setting Range	Default Value	Modification	Serial No
F4.05	Skip frequency	0.00~F0.04	0.00Hz	※	102.
F4.06	Skip frequency range	0.00~99.99Hz	0.00Hz	※	103.
F4.07	Traverse frequency range	0.0~100.0% (relative to set frequency)	0.0%	※	104.
F4.08	Kick frequency range	0.0~50.0% (relative to traverse frequency range)	0.0%	※	105.
F4.09	Traverse frequency up time	0.1~360.0s	5.0s	※	106.
F4.10	Traverse frequency down time	0.1~360.0s	5.0s	※	107.
F4.11	Fault auto-reset times	0~3	0	※	108.
F4.12	Interval time setting of automatic resetting fault	0.1~100.0s	1.0s	※	109.
F4.13	FDT level detection value	0.00~ F0.04	50.00Hz	※	110.
F4.14	FDT delay detection value	0.0~100.0%(FDT level)	5.0%	※	111.
F4.15	Frequency reaching detection range	0.0~100.0%(maximum frequency)	0.0%	※	112.
F4.16	Brake Threshold Value Voltage	115.0~140.0%(standard DC bus voltage) 380V	130.0%	※	113.
		115.0~140.0%(standard DC bus voltage) 220V	120.0%		
F4.17	Speed display ratio	0.1~999.9% Speed=120×running frequency×F4.17/pole number	100.0%	※	114.
F4.18	PID setpoint Sources Option	0: Given by Keyboard(F4.19)	0	●	115.
		1: Given by panel potentiometer V			
		2: Given by external terminal AI			
		3: Given by Remote Communication			
	4: Multi-seg setpoint				
F4.19	Preset PID setpoint	0.0%~100.0%	0.0%	※	116.
F4.20	PID Feedback Sources Option	0: Reserved	0	●	117.
		1: AI Feedback			
		2: Reserved			
	3: Communication feedback				
F4.21	PID Output Characteristics Option	0: positive	0	●	118.
		1: negative			

Function Code	Name	Setting Range	Default Value	Modification	Serial No
F4.22	Proportional gain (Kp)	0.00~99.99	1.00	※	119.
F4.23	Integral time (Ti)	0.01~10.00s	0.10s	※	120.
F4.24	Differential time (Td)	0.00~10.00s	0.00s	※	121.
F4.25	Sampling cycle time (T)	0.01~99.99s	0.10s	※	122.
F4.26	PID control discrepancy limit	0.0~100.0%	0.0%	※	123.
F4.27	Feedback disconnection detecting value	0.0~100.0%	0.0%	※	124.
F4.28	Feedback disconnection detecting time	0.0~360.0s	1.0s	※	125.
F4.29	Multi-Speed 0	-100.0~100.0%	0.0%	※	126.
F4.30	Multi-Speed 1	-100.0~100.0%	0.0%	※	127.
F4.31	Multi-Speed 2	-100.0~100.0%	0.0%	※	128.
F4.32	Multi-Speed 3	-100.0~100.0%	0.0%	※	129.
F4.33	Multi-Speed 4	-100.0~100.0%	0.0%	※	130.
F4.34	Multi-Speed 5	-100.0~100.0%	0.0%	※	131.
F4.35	Multi-Speed 6	-100.0~100.0%	0.0%	※	132.
F4.36	Multi-Speed 7	-100.0~100.0%	0.0%	※	133.
F5 Protection Parameters					
F5.00	Motor Overload Protection Option	0: No protection	1	●	134.
		1: Normal motor			
		2: Variable Frequency motor			
F5.01	Motor Overload Protection Current	20.0%~120.0% (motor rated current)	100.0%	※	135.
F5.02	Power-down Frequency Drop Point	70.0~110.0%(standard bus voltage)	80.0%	※	136.
F5.03	Instant power-down Frequency drop rate	0.00Hz~99.99Hz	0.0Hz	※	137.
F5.04	Over-voltage Stall Protection	0: prohibit	0	※	138.
		1: allow			
F5.05	Over-voltage Stall Protection Voltage	110~150V(380V)	120%	※	139.
		110~150V(220V)	115%		
F5.06	Over-current stall setting	100~200%	150%	※	140.
F5.07	Over-current gain setting to avoid of stalling	0~100	20	※	141.

Function Code	Name	Setting Range	Default Value	Modification	Serial No
F6 Communication Parameters					
F6.00	Communication Address	1~247,0 is the broadcast address	1	※	142.
F6.01	Baud rate setting	0: 1200BPS	3	※	143.
		1: 2400BPS			
		2: 4800BPS			
		3: 9600BPS			
		4: 19200BPS			
F6.02	Data pattern	0:No check (N,8,1) for RTU	0	※	144.
		1:Odd check (E,8,1) for RTU			
		2:Even check (O,8,1) for RTU			
		3:No check (N,8,2) for RTU			
		4:Odd check (E,8,2) for RTU			
		5:Even check (O,8,2) for RTU			
		6:No check (N,7,1) for ASCII			
		7:Odd check (E,7,1) for ASCII			
		8:Even check (O,7,1) for ASCII			
		9:No check (N,7,2) for ASCII			
		10:Odd check (E,7,2) for ASCII			
		11:Even check (O,7,2) for ASCII			
		12:No check (N,8,1) for ASCII			
		13:Odd check (E,8, 1) for ASCII			
		14:Even check (O,8,1) for ASCII			
		15:No check (N,8,2) for ASCII			
		16:Odd check (E,8,2) for ASCII			
17:Even check (O,8,2) for ASCII					
F6.03	Communication response delay	0~200ms	5ms	※	145.
F6.04	Communication overtime fault time	0.0 (invalid) , 0.1~100.0s	0.0s	※	146.
F6.05	Communication error measure	0: Alarm and free run stop	1	※	147.
		1: No alarm and keep running			
		2: No alarm and stop according to stop mode(by communication)			

Function Code	Name	Setting Range	Default Value	Modification	Serial No
F6.06	Response measure	3: No alarm and stop according to stop mode (by all control mode)	0	※	148.
		0: Response when write			
		1: No response when write			

## Chapter 6 Parameter Description

### F0 Basic Function Parameters

Function Code	Name	Setting Range	Default Value
F0.00	Control mode	1: V/F control	1

#### V/F Control Mode

V/F control mode is suitable for the application which does not require high control accuracy, e.g. pump and fans, and also suitable for cases with one inverter driving multiple motors.

Function Code	Name	Setting Range	Default Value
F0.01	Command source selection	0: Keyboard	0
		1: Terminal	
		2: 485 communication	

Path Selection for the inverter Control Command

0: Keyboard Command Path

The buttons RUN and STOP on the keyboard are for operation control.

1: Terminal Command Path

Multifunction input terminals of forward, reverse, forward jogging, reverse jogging and so on, perform the operation command control.

2: Communication Command Path

Operation command control is performed through communication pattern by upper level machine.

Function Code	Name	Setting Range	Default Value
F0.02	Keyboard and terminal UP/DOWN setting	0: Keyboard and terminal UP/DOWN setting	0
		1: Valid, and inverter does not memorize when power down	
		2: Invalid	

DZB200series inverter can set up the frequency through "▲" and "▼" buttons on the keyboard and terminal UP/DOWN (Frequency setting increase / Frequency setting decrease), and as it has the highest priority, it can combine with any other frequency setting path to mainly accomplish the fine adjustment of inverter output frequency during control system commissioning.

0: Valid, and the inverter memorizes when power down. Able to set up frequency command, and memorize this set frequency when the inverter is power down. When the power is back, automatically combine it with current frequency setting.

1: Valid, and the inverter does not memorize when power is down. Able to set up frequency, but when the inverter power is down, this frequency setting is not memorized.

2: Invalid. The frequency set through keyboard and terminal UP/DOWN is automatically cleared, and the settings through keyboard and terminal UP/DOWN are invalid.

**Note:** After the user restores the default values of inverter function parameters, the frequency value, set through keyboard and terminal UP/DOWN, is automatically cleared.

Function Code	Name	Setting Range	Default Value
F0.03	Frequency command Selection	0: Keyboard	0
		1: Panel potentiometer VI	
		2: External terminal AI	
		3: Reserved	
		4: Multi-speed	
		5: PID control	
		6: 485 communication	

Selection of inverter frequency command input channels. There are 7 main frequency setting channels:

0: Keyboard

Accomplish keyboard frequency setting by means of modifying the value of function code F0.07

“Keyboard frequency setting” .

1: VI

2: External terminal AI

This means that the frequency is set up through analog input terminals. DZB series inverter provides 2 analog input channel. AV1 is 0-10V voltage input mode, while AC1 is 0 (4)-20mA input.

The 100.0% setting of analog input is corresponding to the maximum frequency (Function Code F0.04), and -100.0% is corresponding to maximum reverse frequency (Function Code F0.04).

3:Reserved

4:Multi-speed operation

The inverter is operated in the mode of multi-speed once this frequency setting mode is chosen. It is needed to set up the parameters of F2 Group and F4 Group “Multi-speed control group” to determine the coincidence relation between given percentage and given frequency.

5: PID control

Selection of this parameter means that the operation mode of inverter is PID control mode. In this case, it is required to set up F4 Group “PID control group” . The operation frequency of inverter is the frequency value which PID gives. Please refer to the description of F4 Group “PID functions” for the definition of PID setpoint source, assigned value, feedback source and so on.

6: Remote communication

The frequency command is given in the communication mode by upper position machine. For details, please refer to “DZB Series inverter ModBus Communication Protocol” .

Function Code	Name	Setting Range	Default Value
F0.04	Maximum output frequency	10.00~600.00Hz	50.00Hz

It is used to set up the maximum output frequency of inverter. Please note that, it is the basis of frequency setting and acceleration/deceleration speed.

Function Code	Name	Setting Range	Default Value
F0.05	Upper limit frequency	F0.06~F0.04	50.00Hz

It is the upper limit of inverter output frequency, which should be less than or equal to the maximum output frequency.

Function Code	Name	Setting Range	Default Value
F0.06	Lower limit frequency	0.00 Hz~F0.05	0.00Hz

The lower limit of inverter output frequency.

If setpoint frequency is lower than lower limit frequency when startup, inverter can not run. operate at the lower limit frequency, stop or be dormant. Therein, Maximum output frequency  $\geq$  upper limit frequency  $\geq$  lower limit frequency.

Function Code	Name	Setting Range	Default Value
F0.07	Keyboard frequency setting	0.00 Hz~F0.04	50.00Hz

When Frequency Command is chosen as “ keyboard Setting ” , this function code value is the initial set value of inverter frequency.

Function Code	Name	Setting Range	Default Value
F0.08	ACCEL time 1	0.1~360.0s	10.0s
F0.09	DECEL time 1	0.1~360.0s	10.0s

Acceleration time means the time t1 required for inverter to accelerate to the maximum output frequency (F0.04) from 0Hz.

Deceleration time is the time t2 required for inverter to decelerate to 0Hz from the maximum output frequency (F0.04).

It is indicated by following figure

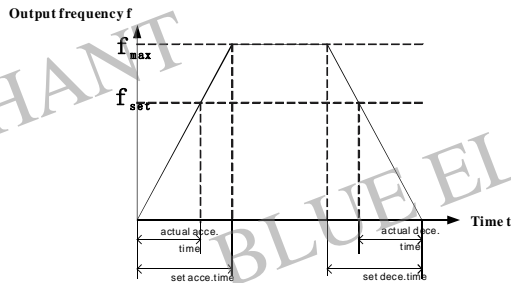

Fig 6-1 Acceleration and Deceleration time diagram

When the set frequency is equal to the maximum frequency, the actual Acceleration/Deceleration time are equal to the set Acceleration/Deceleration time.

When the set frequency is less than the maximum frequency, the actual Acceleration/Deceleration time are less than the set Acceleration/Deceleration time.

Actual Acceleration /Deceleration time = set Acceleration/Deceleration time × (set frequency/max. frequency)

DZB200&300 series inverter has 2 groups of Acceleration/Deceleration time.

1st group: F0.08, F0.09;

2nd group: F4.00, F4.01;

The Acceleration /Deceleration time can be chosen through multifunction digital input terminal (F2 Group).

Function Code	Name	Setting Range	Default Value
F0.10	Operation direction selection	0: Operating at default direction	2
		1: Operating at reverse direction	
		2: NO inverse operating	

0: Operating at default direction. When the inverter is power connected, it operates at the actual direction.

1: Operating at reverse direction. By means of changing the function code, the motor rotating direction can be changed without changing any other parameters, which is equivalent to change the motor rotating direction by exchanging any two of motor cables (U, V, W).

*Note: After the parameters are initialized, the motor operating direction can be restored to be its original state. Be caution to use it in the case that changing motor rotating direction is forbidden after the system commissioning is completed.*

2: Forbid inverse operating. Forbidding inverter inverse operation is suitable to specific application that inverse operating is forbidden.

Function Code	Name	Setting Range	Default Value Set by model
F0.11	Carrier frequency setting	1.0~15.0kHz	

Carrier frequency	Electromagnetic noise	Cacophony Leakage current	Heat radiation
1KHz	↑ large	↑ small	↑ small
10KHz	↕	↕	↕
15KHz	↓ small	↓ large	↓ large

Fig 6-2 Relationship between environment and Carrier frequency

Relationship between Model and Carrier frequency

Carrier frequency	Max carrier frequency (KHz)	Min carrier frequency (KHz)	Factory setting (KHz)
Model B: 0.4kW~11KW P: 0.75kW~15KW	15	1	8
B: 15kW~55KW P: 18.5kW~75KW	8	1	4
B: 75kW~300KW P: 90kW~315KW	6	1	2

This function is mainly used to improve the motor operating noise and inverter interference to external.

The advantages of using high carrier frequency: relatively ideal current wave shape, less harmonic current wave and low motor noise;

The disadvantages of using high carrier frequency: increased switch loss and inverter temperature rises, affecting inverter output capacity so that it should be operated at derating under high carrier frequency conditions; in the mean time, inverter leakage current and its electromagnetic interference to external are increased.

The situations of using low carrier frequency is on the contrary. Too low carrier frequency can cause operation unstable, torque reduced and even oscillation at low frequency.

When inverter is factory released, its carrier frequency has been set properly. Generally the user does not need to modify this parameter.

Function Code	Name	Setting Range	Default Value
F0.12	Functional parameters restoration	0: NO operation	0
		1: Restore default value	
		2: Delete failure records	

1: The inverter restores all parameters to their default value.

2: The inverter deletes recent failure records.

After the chosen function operation is completed, this function code is automatically restored to 0.

Function Code	Name	Setting Range	Default Value
F0.13	AVR selection	0: Invalid	1
		1: Valid all the time	
		2: Invalid during deceleration	

AVR means output voltage auto regulation. When AVR is invalid, output voltage will change according to the change of input voltage (or DC bus voltage); When AVR is valid, output voltage will remain constant within output capacity.

Function Code	Name	Setting Range	Default Value
F0.14	Start Mode	0: Direct start	0
		1: DC braking first and then start	
		2: Running speed pick-up and then start	

0: Direct start: start from the starting frequency.

1: DC braking first and then start: First perform DC braking (pay attention to set up parameters F0.17 and F0.18), and then start and run the motor at the start frequency. It is suitable for small inertia loading which can cause reverse rotation at starting.

2: Running speed pick-up and then start: the inverter first calculates motor rotating speed and direction, and then start running to its set frequency from current speed, performing a smooth no-shock start to moving motor. This mode is applicable to momentary power-down start when the inertia loading is big.

Function Code	Name	Setting Range	Default Value
F0.15	Start frequency	0.5~99.99Hz	0.50Hz
F0.16	Hold time of start frequency	0.0~50.0s	0.0s

Setting proper starting frequency can increase the starting torque. Within the hold time of the starting frequency (F0.16), the inverter output frequency is the starting frequency, and then, from the starting frequency, running to the target frequency. If the target frequency (frequency command) is less than the

starting frequency, inverter does not operate and is at stand-by state. The starting frequency value is not restricted by the lower limit frequency.

During FWD/REV switching, the starting frequency is inactive.

Function Code	Name	Setting Range	Default Value
F0.17	Braking current before starting	0.0~150.0%	0.0%
F0.18	Braking time before starting	0.0~50.0s	0.0s

When it is being started, the inverter first performs DC braking according to the set prior-to-starting DC braking current, and after the set prior-to-starting DC braking time is passed then begins to perform acceleration. If the set DC braking time is 0, DC braking is invalid.

The bigger the DC braking current, the greater the braking force. The prior-to-starting DC braking current is the percentage of the rated inverter current.

Function Code	Name	Setting Range	Default Value
F0.19	Stop Mode	0: DECEL Stop	0
		1: Free run Stop	

0: Deceleration stop

After the stop command is enabled, the inverter decreases the output frequency according to the Deceleration mode and the defined Acceleration/Deceleration time, and the motor is stopped when the frequency is 0.

1: Free-run stop

Once the stop command is valid, the inverter immediately ends the output. The loading is freely stopped by its mechanical inertia.

Function Code	Name	Setting Range	Default Value
F0.20	Beginning Frequency of braking	0.00~99.99Hz	0.00Hz
F0.21	Waiting time of braking	0.0~50.0s	0.0s
F0.22	DC braking current	0.0~150.0%	0.0%
F0.23	DC braking time	0.0~50.0s	0.0s

Beginning frequency of DC brake when stopping. During the Deceleration stop, when this frequency is reached, the DC brake is started.

Waiting time of DC brake when stopping: Prior to the DC brake, the inverter blocks the output, and after this delay time, the DC braking is started. It is used to prevent over-current fault caused by DC braking at high speed.

DC brake current when stopping: indicates the applied DC brake energy. The bigger the current, the stronger the DC brake energy should be.

DC brake time when stopping: the durative time that the DC brake energy is applied. If the time is 0, DC brake is invalid, and the inverter stops the motor based on the set Deceleration time.

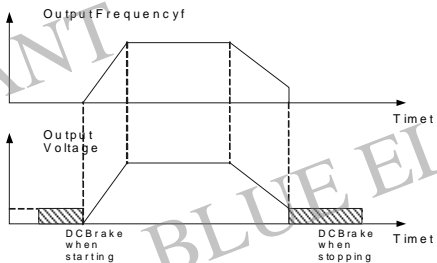

Fig. 6-3 DC Brake Diagram

Function Code	Name	Setting Range	Default Value
F0.24	Dead time between forward and reverse	0.0~360.0s	0.0s

It is to set the transient time during which the output frequency is 0 in the FWD/REV transient process of inverter.

It is shown as following figure:

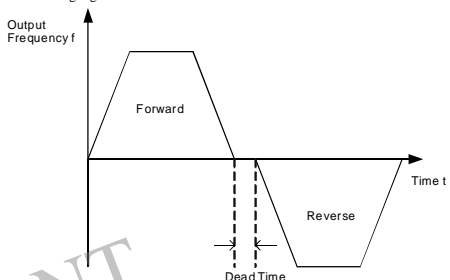

Fig. 6-4 FWD/REV Dead Time Diagram

Function Code	Name	Setting Range	Default Value
F0.25	Terminal command protection when power on	0: Terminal command invalid when power on 1: Terminal command valid when power on	0

If operating command channel is set to terminal control, system will detect terminal status automatically during inverter power on.

- 0: Terminal command invalid when power on. Inverter will not run if it detect operating command terminal is valid. When the operating command terminal is invalid and enable this terminal again, inverter will run.
- 1: Terminal command valid when power on. Inverter will startup automatically after initialization is finished if it detect operation command terminal is valid.

*Note: Customer should be careful when you select this function, it may cause severe consequence.*

### F1 Motor Parameters

Function Code	Name	Setting Range	Default Value
F1.00	Reserved		
F1.01	Motor rated power	0.4~55.0kW	Set by model
F1.02	Motor rated frequency	0.01Hz~F0.04	50.00Hz
F1.03	Motor rated speed	0~9999rpm	Set by model
F1.04	Motor rated voltage	0~460V	Set by model
F1.05	Motor rated current	0.1~100.0A	Set by model
F1.06	Motor stator resistance	0.001~9.999Ω	Set by model
F1.07	Motor rotor resistance	0.001~99.99Ω	Set by model
F1.08	Motor stator/rotor inductance	0.1~999.9mH	Set by model
F1.09	Mutual inductance of motor stator/rotor	0.1~999.9mH	Set by model
F1.10	No-load current	0.01~99.99A	Set by model
F1.11	Self-learning of motor parameters	0: NO operation	0
		1: complete tuning Self-learning	
		2: static tuning Self-learning	
F1.12	Speed loop proportional gain1	0~100	30
F1.13	Speed loop integral time1	0.01~10.00s	0.50s
F1.14	Switching low point frequency	0.00Hz~F1.17	5.00Hz
F1.15	Speed loop proportional gain 2	0~100	25
F1.16	Speed loop integral time 2	0.01~10.00s	1.00s
F1.17	Switching high point frequency	F1.14~99.99Hz	10.00Hz
F1.18	VC slip compensating factor	50%~200%	100%



Function Code	Name	Setting Range	Default Value
F1.19	Upper torque limit setting	0.0~200.0%(inverter rated current)	150.0%

The setting 100.0% is corresponding to the rated output current.

Function Code	Name	Setting Range	Default Value
F1.20	V/F curve setting	0: Linear V/F curve	0
		1: square torque V/F curve	

0: Linear V/F curve. It is applicable to constant torque load.

1: 2.0 exponential V/F curve. It is applicable to variable torque load, such as blower, pump etc.

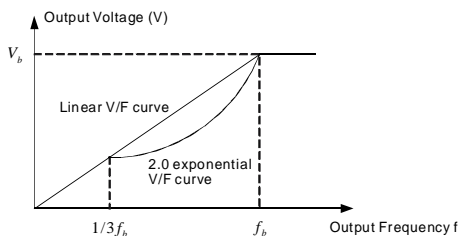

Fig. 6-6 V/F curve diagram

Function Code	Name	Setting Range	Default Value
F1.21	Torque boost	0.0%: (auto) 0.1%~30.0%	0
F1.22	Torque boost cut-off	0.0%~50.0% (relative to motor rated frequency)	20.0%

Torque Boost is mainly applied to less than cut-off frequency (F1.22). The V/F curve after boost is shown in following figure. Torque boost can improve the low frequency torque performance of V/F control.

Based on the load, a torque should be chosen properly. For heavy load, increase the torque boost, but the torque boost should not be set too big, which will result in the motor operating at overexcitation and that it could be overheated, and also the inverter output current is big, reducing efficiency.

When the torque boost is set as 0.0%, the inverter is at automatic torque boost.

Torque boost cut-off frequency: below this frequency, torque boost is valid, and above this frequency setting, torque boost is invalid.

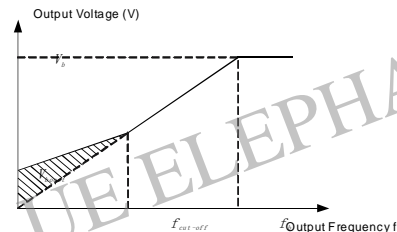

Fig. 6-7 Manual torque boost diagram

Function Code	Name	Setting Range	Default Value
F1.23	V/F slip compensation limit	0.0~200.0%	100%

Setting this parameter can compensate the motor speed change produced because of undertaking loading while on V/F control, to increase the rigidity of motor mechanical performance. This value should be set as the motor rated slip frequency.

Function Code	Name	Setting Range	Default Value
F1.24	Energy Conservation Selection	0: No Operation	0
		1: Energy Conservation	

When the motor is running in no-load or lower-load during, the inverter can adjust output voltage by automatically current kf the load.

*Note: This function is especially valid for variable torque load (such as fan and pump).*

## F2 Input and Output Terminal Function Parameters

Function Code	Name	Setting Range	Default Value
F2.00	On-off signal filter times	1~10	5

It sets up S1-S6, VI and CI terminals sample filtering time. In big interference situation, this parameter should be increased in order to prevent maloperation.

Function Code	Name	Setting Range	Default Value
F2.01	S1 Terminal Function Selection	0~25	1
F2.02	S2 Terminal Function Selection	0~25	2
F2.03	S3 Terminal Function Selection	0~25	4
F2.04	S4 Terminal Function Selection	0~25	7
F2.05	S5 Terminal Function Selection	0~25	12
F2.06	S6 Terminal Function Selection	0~25	13

These parameters are used to set up the corresponding functions of digital multifunction input terminals.

setting value	Function	Description
0	No Function	Even if there is a signal input, the inverter does not run. Terminals which are not used can be set to be no function in order to prevent malfunction
1	Forward	The inverter's forward or reverse running can be control by external terminals.
2	Reverse	
3	three-wire operation control	By means of this terminal the inverter's operation mode can be defined to be three-wire control mode. For details, please refer to the function code description of F2.07 three-wire control mode.
4	Forward Jogging	At Jogging operation, the frequency and Jogging Acceleration/Deceleration time can be found in detail descriptions of F4.02,F4.03 and F4.04 function codes.
5	Reverse Jogging	
6	Free-run stop	The inverter turns off output, and the motor stop process is not controlled by the inverter. It is often applied when the inertia loading is big and there is no requirement on stop time. This mode has the same definition as F0.19 does.
7	Failure reset	This is external failure reset. It has the same function as STOP button on the keyboard. Using this function can perform long-distance failure reset.
8	External fault input	When external fault signal is input, the inverter reports it and stops.

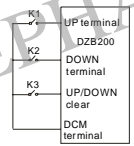
9	Frequency up setting	When the frequency is set by external terminal, modify the frequency up and down command. When the frequency source is set as digital setting, the set frequency can be regulated up and down.									
10	Frequency down setting										
11	Frequency up/down setting clear		Using terminal can clear UP/DOWN set frequency so that set frequency can be restored the frequency setting given by frequency command channel.								
12	Multi-speed terminal 1	8 stages speed can be set up via these 3 terminals digital state combination. Note: multi-speed 1 is the low position, and multi-speed 3 is the high position.									
13	Multi-speed terminal 2										
14	Multi-speed terminal 3										
15	ACCE/DECE time selection terminal	2 kinds of ACCE/DECE time can be chosen via these two terminals digital state combination. <table border="1" data-bbox="1156 529 1536 626"> <thead> <tr> <th>Terminal</th> <th>ACC/DEC time selection</th> <th>Parameter</th> </tr> </thead> <tbody> <tr> <td>OFF</td> <td>ACCE time 1</td> <td>F0.08、F0.09</td> </tr> <tr> <td>ON</td> <td>ACCE time 2</td> <td>F4.00、F4.01</td> </tr> </tbody> </table>	Terminal	ACC/DEC time selection	Parameter	OFF	ACCE time 1	F0.08、F0.09	ON	ACCE time 2	F4.00、F4.01
Terminal	ACC/DEC time selection	Parameter									
OFF	ACCE time 1	F0.08、F0.09									
ON	ACCE time 2	F4.00、F4.01									
16	PID control pause	PID is temporarily out of work, and the inverter keeps its current frequency output.									
17	Traverse pause	The inverter pauses at its current output frequency. After this function is cancelled, continue to start its traverse operation at its current frequency.									
18	Traverse reset	The inverter is back to its center frequency output.									
19	Acceleration/Deceleration forbid	Ensure the inverter is not interfered by external signals (excluding stop command), maintaining its current output frequency.									
20	Reserved	Reserved									
21	External accel terminal	When the key-press valid, it is automated to turn to display motor speed. Accel/Decel adjust invalid when at stop status.									
22	External decel terminal										
23	Setting delay time(up)	When the key-press valid, it is automated to turn to display time setting. F3.18 sets to 0, terminal adjust invalid.									
24	Setting delay time(down)										
25	Programme running invalid	When the key valid, we can set programme running mode.									
26	Programme running reset										

Function Code	Name	Setting Range	Default Value
F2.07	Terminal control mode	0: two-wire control 1	0
		1: two-wire control 2	
		2: three-wire control 1	
		3: three-wire control 2	

This parameter defines four different control modes which controls the inverter operation through external terminals.

0: Two-wire type control, integrate Enable with direction. This mode is the most often used two-wire control mode. The motor forward and reverse operations are determined by the defined FWD and REV terminal command.

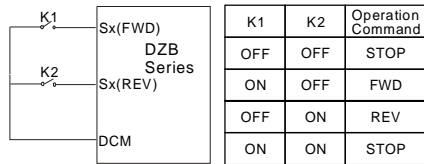

Fig. 6-8 Two-wire operation mode 1

1: Two-wire control, separate Enable from direction. When this mode is used, the defined FWD is enable terminal. The direction is determined by the defined REV state.

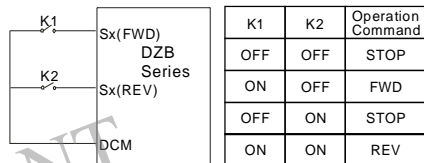

Fig. 6-9 Two-wire operation mode 2

2: Three-wire control 1, integrate Enable with direction. At this mode, EN is the Enable terminal with the direction controlled by the defined FWD. REV define the direction.

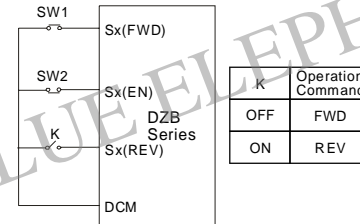

Fig. 6-10 Three-wire operation mode 1

K: FWD/REV switch SW1: RUN button SW2: STOP button  
EN is defining the corresponding terminal function as Function 3 "Three-wire operation control".

3: Three-wire control, separate Enable from direction. At this mode EN is the Enable terminal, SW1 or SW2 define operating command and control direction at the same time. Stop command is defined by SW2.

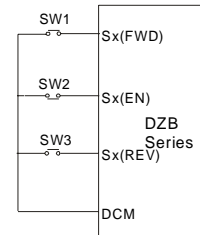

Fig. 6-11 Three-wire operation mode 2

SW1: FWD operating button SW2: STOP button SW3: REV operating button  
EN is defining the corresponding terminal function as Function 3 "Three-wire operation control".

*Note: For two-wire operation mode, when FWD/REV terminal is enabled and the stop command produced by other sources stops the equipment, the inverter does not start to operate after the stop command disappears even if the control terminal FWD/REV is still valid. If the inverter needs to operate, it is required to trigger FWD/REV again.*

Function Code	Name	Setting Range	Default Value
F2.08	UP/DOWN frequency increment variable rate	0.01~99.99Hz/s	0.50Hz/s

Terminal UP/DOWN regulates the change rate of frequency setting.

Function Code	Name	Setting Range	Default Value
F2.09	VI lower limit	0.0V~10.0V	0.0V
F2.10	VI lower limit corresponding setting	-100.0%~100.0%	0.0%
F2.11	VI upper limit	0.0V~10.0V	10.0V
F2.12	VI upper limit corresponding setting	-100.0%~100.0%	100.0%
F2.13	VI input filtering time	0.0s~10.0s	0.1s

Above function codes define the relationship between analog input voltage and the setting value that analog input is corresponding to. When the analog input voltage exceeds the range of the set maximum or minimum input, the beyond portion should be calculated with maximum input or minimum input.

When analog input is amperage input, 0mA-20mA is corresponding to 0V-10V.

For different applications, the corresponding nominal value of analog setting 100.0% is different. For details, please refer to each application description.

Following figures shows several settings. Note: VI lower limit must be less or equal to VI upper limit.

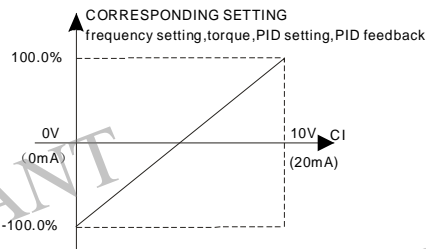

Fig. 6-12 Relationship between analog input and setting value

VI input filtering time determines analog input sensitivity. Increasing this parameter, in order to prevent malfunction caused by interference to the analog, can strengthen the anti-interference ability, but reduce the analog input sensitivity.

Function Code	Name	Setting Range	Default Value
F2.14	CI lower limit	0.0V~10.0V	0.0V
F2.15	CI lower limit corresponding setting	-100.0%~100.0%	0.0%
F2.16	Clupper limit	0.0V~10.0V	10.0V
F2.17	CI upper limit corresponding setting	-100.0%~100.0%	100.0%
F2.18	CI input filtering time	0.0s~10.0s	0.1s

CI function settings are similar to VI setting method.

DZB Series inverter provides 2 paths of analog input port.

DZB Series inverter standard unit has two multifunction digital output terminal, one (or two) multifunction relay output terminals and one analog output terminal.

Function Code	Name	Setting Range	Default Value
F2.19	Mo1 output selection	0~10	1
F2.20	Reserved		
F2.21	Relay output selection	0~10	3

Open collector output functions are indicated as following table:

Setting Value	Function	Description
0	Zero Output	Output terminal has no function
1	Frequency reaches	please refer to the detail description of function code F4.15
2	FDT reaches	please refer to the detail description of function code F4.13,F4.14
3	Fault output	Once inverter fault happens, output ON signal
4	Inverter is running forward	ON signal Indicates the inverter is running forward with output frequency.
5	Inverter is running reverse	ON signal Indicates the inverter is running reverse with output frequency.
6	Null speed operation	When the inverter output frequency is less than the starting frequency, output ON signal
7	Upper limit frequency reaches	When the operating frequency reaches the upper frequency limit, output ON signal.
8	Lower limit frequency reaches	When the operating frequency reaches the lower frequency limit, output ON signal.
9~10	Reserved	Reserved
11	high pressure reaches detection(NC)	Pressure reaches at the F7.12 low pressure setting,NC output indication.
12	low pressure reaches detection(NC)	Pressure reaches at the F7.13 high pressure setting,NC output indication.
13	high pressure reaches detection(NO)	Pressure reaches at the F7.12 high pressure setting,NO output indication.

14	low pressure reaches detection(NO)	Pressure reaches at the F7.13 low pressure setting,NO output indication signal.
15	sleeping status indicates	During sleeping status,output ON signal and display "EOPP"
16	no water indicates	No water alarms,output ON signal and display "EOP2"
17	no zero-speed running	When output frequency is bigger than the lowest output frequency,output ON signal.
18	running	When the inverter has output signal or running order input, output ON signal.

Function Code	Name	Setting Range	Default Value
F2.22	FM Analog output selection	0~10	0

The standard analog output is 0-20mA (or 0-10V). Current or voltage output can be selected by Jumper S2. Its corresponding value range is shown as following table:

Setting Value	Function	Range
0	Setting frequency	0-maximum output frequency
1	Operating frequency	0-maximum output frequency
2	Output current	0-double rated inverter current
3	Output voltage	0-double rated inverter voltage
4	Motor speed	0-double rated motor speed
5	Output power	0-double rated power
6	Output torque	0-double rated motor current
7	Analog VI input	0~10V
8	Analog CI input	0~10V/0~20mA
9~10	Reserved	Reserved

Function Code	Name	Setting Range	Default Value
F2.23	AO Lower limit	0.0%~100.0%	0.0%
F2.24	Lower limit corresponding AO output	0.0V~10.0V	0.0V
F2.25	AO Upper limit	0.0%~100.0%	100.0%
F2.26	Upper limit corresponding AO output	0.0V~10.0V	10.0V

Above function codes define the relationship between output value and analog output corresponding output value. When the output value exceeds the maximum output or the minimum output range, the beyond portion should be calculated with maximum output or minimum output.

When analog output is current output, 1mA is equivalent to 0.5V

For different applications, the analog output corresponding to 100% output value is different. For details, please refer to the instruction of each application.

Following figures explain several setting circumstances:

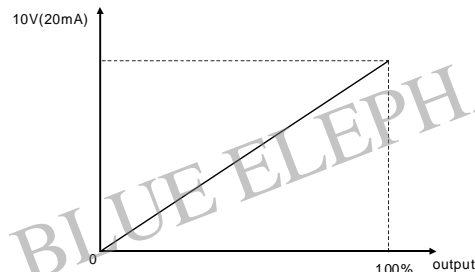

Figure 6-13 The coincidence relationship between assigned value and analog output

### F3 Human Machine Interface Parameters

Function Code	Name	Setting Range	Default Value
F3.00	User password	0~9999	0

User password is applied to prevent non-authorized person to look and modify parameter. Input a nonzero five digit number as password, then press DATA/ENT to confirm, if there is no button operation in one minute, password function becomes effective.

After password becomes effective, customer can not access parameter list if password input is incorrect. Please remember the password. If it is not necessary to set password, just set 0000 to clear password.

Function Code	Name	Setting Range	Default Value
F3.01	Reserved		
F3.02	Reserved		

Function Code	Name	Setting Range	Default Value
F3.03	STOP function option	0: Keypad control valid	0
		1: Keypad and terminal control valid	
		2: Keypad and communication control valid	
		3: All control modes valid	

This function code is to define the STOP stop function validity options.

Function Code	Name	Setting Range	Default Value
F3.04	Keypad display option	0: external keyboard preferential ENB	0
		1: Local and external keyboard simultaneous display, only external key-press is valid.	
		2: Local panel and external keyboard simultaneous display, only Local key-press is valid.	
		3: Local and external keyboard simultaneous display, and all key-presses are valid (both are OR logical relation)	

This function is to set up the logical relationship between Local and external keyboard key-press.

**Note: No. 3 function should be used cautiously. Maloperation may cause serious consequences.**

Function Code	Name	Setting Range	Default Value
F3.05	operation status display parameter option	0-32767	255
F3.06	Stop status display parameter option	0-2048	255
F3.07	operation status display preferential option	0-14(0:invalid)	0

operation status display

Displayed Message	Code
0:Setting frequency	1
1:Running frequency	2
2:Output current	4
3:Output voltage	8
4:Running speed	16
5:Actual delay time	32
6:Setting delay time	64
7:DC bus voltage	128
8:PID setpoint	256
9:PID feedback	512
10:Input terminal status	1024
11:Output terminal status	2048
12:VI value	4096
13:CI value	8192
14:Current segment of multi-speed control	16384

Stop status display

Displayed Message	Code
Setting frequency	1
DC bus voltage	2
Input terminal status	4
Output terminal status	8
PID setpoint	16
PID feedback	32
VI value	64
CI value	128
Current segment of multi-speed control	256
Actual delay time	512
Setting delay time	1024

Opion: setting parameter=the sum total of display code, for example:

require to display at operation status:Output current,Running speed,Output power 4+16+32=52, then setting F3.05to 52. its corresponding parameter can be viewed at operation through pressing button "DATA".

This I/O terminal status is displayed in decimal system, S1 (MO1) corresponding to the lowest digit. For instance, input status displays 3 is indicating that terminal S1 and S2 are closed and others are open. For details, please see F3.17 and F3.18 description.

Function Code	Name	Setting Range	Default Value
F3.08	IGBT module temperature	0~100.0℃	
F3.09	Software version		
F3.10	Accumulative operating time	0~9999h	0

These functions only can be viewed but can not be modified.

IGBT module temperature: indicates the temperature of the inverter IGBT module.

Over-temperature protection value of different inverter may be different.

Software version: software version number.

Inverter accumulative operating time: displays current inverter accumulative operation time.

Function Code	Name	Setting Range	Default Value
F3.11	The fault before previous fault type		
F3.12	Previous fault type		
F3.13	Current fault type		

Record three recent fault types: 0 is no fault; 1~22 is 22 different kinds of fault. For details, please see fault analysis.

Function Code	Name	Description	Default Value
F3.14	Operating frequency at current fault	The output frequency when current fault happens	0.00Hz
F3.15	Output amperage at current fault	The output amperage when current fault happens	0.0A
F3.16	Bus voltage at current fault	The bus voltage when current fault happens	0.0V

Function Code	Name	Setting Range	Default Value
F3.17	Setting delay time(up)	0~9999	0.0V
F3.18	Setting unit of delay time	0~3 (0:function of delay time invalid)	0.0V

We also can use set external terminal function to set delay time of F3.17.

- Setting unit of delay time 0:delay time function invalid  
 1:the unit of delay time is 0.1s  
 2:the unit of delay time 1s  
 3:the unit of delay time 1min

#### F4 Application Function Parameters

Function Code	Name	Setting Range	Default Value
F4.00	ACCEL Time 2	0.1~360.0s	10.0s
F4.01	DECEL Time 2	0.1~360.0s	10.0s

Acceleration/Deceleration time can be chosen to be F0.08, F0.09 or above three time settings. Their meanings are all the same; please refer to F0.08 and F0.09 related description.

The Acceleration/Deceleration time 0-1 at inverter operation can be chosen through different combination of multifunction digital input terminals.

Function Code	Name	Setting Range	Default Value
F4.02	Jogging frequency	0.00~F0.04	5.00Hz
F4.03	Jogging ACCEL time	0.1~360.0s	10.0s
F4.04	Jogging DECEL time	0.1~360.0s	10.0s

It is to define the inverter set frequency and Acceleration/Deceleration time at Jogging operation. Jogging operation is performed by direct start mode and deceleration stop mode.

The Jogging Acceleration time is the time required for inverter to accelerate from 0Hz to the maximum output frequency (F0.04).

The Jogging Deceleration time is the time required for inverter to decelerate from the maximum output frequency (F0.04) to 0Hz.

Function Code	Name	Setting Range	Default Value
F4.05	Skip frequency	0.00~F0.04	0.00Hz
F4.06	Skip frequency range	0.00~F0.04	0.00Hz

When the set frequency is within the skip frequency range, the actual operating frequency will be operated near the boundary of skip frequency range.

By means of setting skip frequency, the inverter can keep away from the mechanical resonance point of the load.

This inverter has one skip frequency point available. If these two skip frequencies are both set to 0, this function will be inactive.

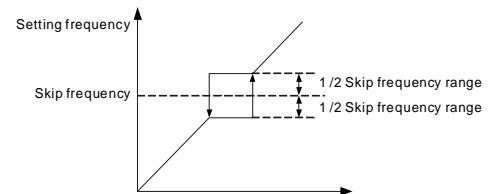

Fig. 6-14 Skip frequency schematic diagram

Function Code	Name	Setting Range	Default Value
F4.07	Traverse frequency range	0.0~100.0% (relative to set frequency)	0.0%
F4.08	Kick frequency range	0.0~50.0%(relative to traverse frequency range)	0.0%
F4.09	Traverse frequency up time	0.1~360.0s	5.0s
F4.10	Traverse frequency down time	0.1~360.0s	5.0s

Traverse frequency function is suitable to industries such as textile, fiber and so on, and to applications which require traversing and winding functions.

Traverse frequency function means that the inverter output frequency is traversing up and down around the set frequency. The operating frequency locus with time axis is shown as following diagram, in which the amplitude of traverse is set by F4.07. When F4.07 is set to be 0, i.e. traverse range is 0, the traverse frequency function will be inactive.

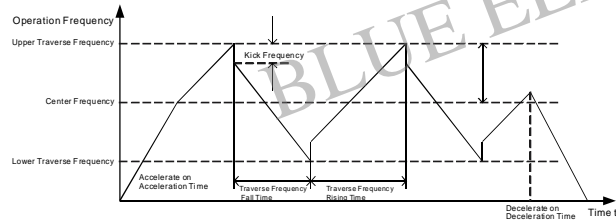

Fig. 6-15 Traverse Frequency Operation Diagram

Traverse frequency range: traverse operation frequency limits by upper and lower limit frequency.

Traverse range relative to the center frequency: amplitude of traverse  $AW = CF \times AW \text{ range F4.07}$

Kick frequency = amplitude of traverse  $AW \times \text{Kick Frequency Range F4.08}$ . I.e. the kick frequency is the value relative to amplitude of traverse at traverse-frequency operation.

Traverse frequency rising time: the time required to rise from the lowest traverse frequency to the highest traverse frequency.

Traverse frequency fall time: the time required to fall from the highest traverse frequency to the lowest traverse frequency.

Function Code	Name	Setting Range	Default Value
F4.11	Fault auto-reset times	0~3	0
F4.12	Interval time setting of automatic resetting fault	0.1~100.0s	1.0s

Fault auto-reset times: used to set the auto-reset times when inverter chooses fault auto-reset. If this value is exceeded, inverter will wait for trouble shooting.

Interval time setting of fault auto-reset: chose the interval time between fault occurring and automatic resetting actuated

Function Code	Name	Setting Range	Default Value
F4.13	FDT level detection value	0.00~ F0.04	50.00Hz
F4.14	FDT delay detection value	0.0~100.0%(FDT level)	5.0%

Set output frequency detection value and the delay value of output action dismissed, as shown by following figure:

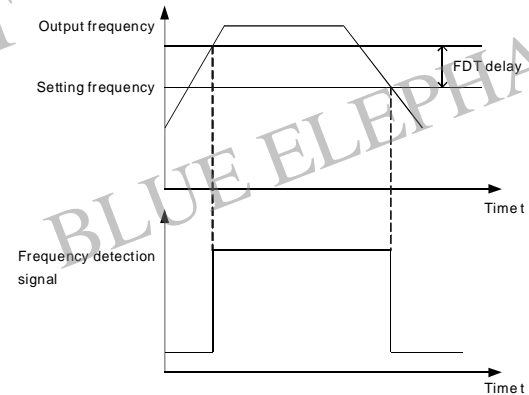

Fig.6-16 FDT Level Diagram

Function Code	Name	Setting Range	Default Value
F4.15	Frequency reaching detection range	0.0~100.0%(maximum frequency)	0.0%

When the inverter output frequency reaches the set frequency value, this function can regulate its detection range value, as shown by following figure:

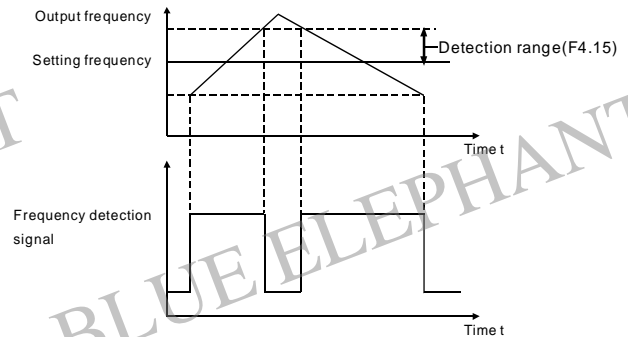

Fig.6-17 Frequency Reaching Detection Range Diagram



Function Code	Name	Setting Range	Default Value
F4.16	Brake Threshold Value Voltage	115.0~140.0%(standard DC bus voltage) 380V	130.0%
		115.0~140.0%(standard DC bus voltage) 220V	120.0%

This function is to set up the initiative bus voltage of dynamic braking, and properly regulating this value can result in an effective brake to the load.

Function Code	Name	Setting Range	Default Value
F4.17	Speed display ratio	0.1~999.9% Speed=120×running frequency×F4.17/pole number	100.0%

Speed=120×running frequency×F4.17/pole number

This function is used to calibrate speed display error, it has no impact on actual speed.

PID control is one method normally used to process control, holding the control value to the target value by the negative feedback system which regulates the inverter output frequency by means of proportion, integration and differential operations on the difference between the control value feedback signal and the target value signal. It is applicable to the process controls such as flow control, pressure control and temperature control and so on. The control functional block diagram is shown as follows:

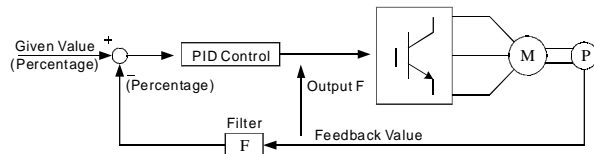

Fig. 6-18 Process PID Functional Block Diagram

Function Code	Name	Setting Range	Default Value
F4.18	PID setpoint Sources Option	0: Given by Keyboard(F4.19)	0
		1: Given by panel potentiometer(VI)	
		2: Given external terminal AI	
		3: Given by Remote Communication	
		4: Multi-seg setpoint	

When frequency source is chosen to be PID, i.e. F0.03 is chosen to be 5, these group functions are active. This parameter is to determine the assignment channel of the process PID target value.

The set target value of process PID is a relative value, and the set 100% is corresponding to the 100% feedback signal of the system being controlled.

The system always performs the calculation according to relative value (0-100%)

**Note: If multistage input, it can be accomplished by means of setting F4 group parameters.**

Function Code	Name	Setting Range	Default Value
F4.19	Preset PID setpoint	0.0%~100.0%	0.0%

When F4.08=0 is chosen, i.e. the target source is the keyboard, it is required to set this parameter.

The reference value of this parameter is the system feedback value.

Function Code	Name	Setting Range	Default Value
F4.20	PID Feedback Sources Option	0: Reserved	0
		1: AI Feedback	
		2: Reserved	
		3: Communication feedback	

The PID feedback channel is chosen by this parameter.

**Important: The assignment channel and feedback channel can not be in coincidence, otherwise PID is unable to control effectively.**

Function Code	Name	Setting Range	Default Value
F4.21	PID Output Characteristics Option	0: positive	0
		1: negative	

PID output is positive characteristic: when the feedback signal is bigger than the PID given signal, it is required for the inverter output frequency to decrease to counterbalance the PID, for instance, the winding tension PID control.

PID output is negative characteristic: when the feedback signal is bigger than the PID giver signal, it is required for the inverter output frequency to increase to counterbalance the PID, for instance, the unreeling tension PID control.

Function Code	Name	Setting Range	Default Value
F4.22	Proportional gain (Kp)	0.00~99.99	1.00
F4.23	Integral time (Ti)	0.01~10.00s	0.10s
F4.24	Differential time (Td)	0.00~10.00s	0.00s

Proportional gain (Kp): determines the adjusting strength of PID adjustor. The bigger the P, the bigger the adjusting strength is. This parameter being 100 means that when the difference between the PID feedback value and the assigned value is 100%, the adjusting range of PID adjustor to the output frequency command is the maximum frequency (ignore integral action and derivative action).

Integrating time (Ti): determines the speed at which PID adjustor performs integral regulation to the discrepancy between the PID feedback value and the assigned value. The Ti is indicating the period of time that integral controller (ignore proportional action and derivative action), when the discrepancy between the PID feedback value and the assigned value is 100%, continuously regulates to make the regulating amount to reach the maximum frequency (F0.047). The shorter the integrating time, the stronger the adjusting strength is.

Differential time (Td): determines the controlling strength at which PID adjustor performs adjustment to the variance ratio of discrepancy between the PID feedback value and the assigned value. The Td is indicating the period of time within which if the feedback value is changed 100%, the regulating amount of integral controller is the maximum frequency (F0.04) (ignore proportional action and integral action). The longer the Td, the bigger the controlling strength is. PID is the most popularly used control mode in process control, with each part playing different role. Following simply introduces the operational principle and the controlling method:

Proportion control (P): when there is discrepancy between feedback and the assignment, output the regulating amount in proportion to the discrepancy. If the discrepancy is constant, the regulating amount keeps constant. Proportion control can response quickly to the feedback variation, but only using proportion control is unable to perform noncorresponding control. The bigger the proportional gain, the faster the system regulating speed, but being too big may cause oscillation. The control method is first to set a long integrating time and a zero differential time, and then run the system only by using proportion control. Change the assigned value, and watch the stable discrepancy (steady-state error) of feedback signal and assigned value. If the steady-state error is at the varying direction of assigned value (for instance, increase the assigned value, the feedback value after the system is steady is always less than the assigned value), continue to increase the proportional gain, otherwise decrease it. Repeat the above until the steady-state error is relatively small (it is very difficult to do no steady-state error).

Integral time (I): when there is a discrepancy between the feedback and assignment, continuously accumulate the output regulation amount. If the discrepancy still exists, continue to increase the regulation amount until there is no discrepancy. Integral controller can effectively eliminate the steady-state error.

Integral controller being too strong can cause repeated overshooting, system unstable and up till oscillating. The characteristic of oscillation caused by too strong integral action is that the feedback signal is swinging up and down around the assigned value, and the amplitude of swing increases gradually till the oscillation happens. Normally the integral time is adjusted from big to small, gradually regulate the integral time, and watch the effect, until the system stable speed meets requirements.

Differential time (D): when the discrepancy between feedback and assignment varies, output a regulation amount in proportion to the variance ratio of discrepancy. The regulation amount is related to the direction and magnitude of discrepancy variation, but irrelevant to the direction and value of the discrepancy itself. The differential control action is to perform the control according to the varying trend when the feedback signal variation happens, and thereby to restrain the feedback signal variation. It should be caution to use differential controller as the differential control have a trend to magnify the system interference, especially the high varying frequency interference.

Function Code	Name	Setting Range	Default Value
F4.25	Sampling cycle time (T)	0.01~99.99s	0.10s
F4.26	PID control discrepancy limit	0.0~100.0%	0.0%

Sampling time (T): is the time to sample the feedback value. In each sampling period the controller runs one time. The longer the sampling time, the slower the responding.

PID control discrepancy limit: the allowable maximum discrepancy of PID system output value relative to the closed-loop assigned value. As shown in following diagram, within the discrepancy limit, PID controller stops adjustment. Properly setting this function code can improve the accuracy and stability of PID system.

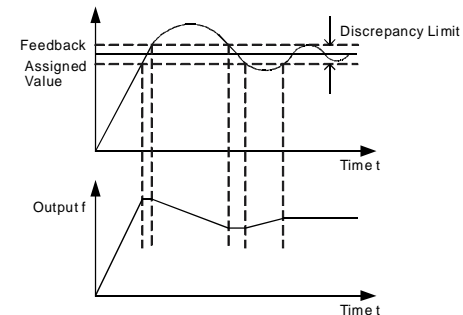

Fig. 6-19 Coincidence relation of discrepancy limit and output frequency

Function Code	Name	Setting Range	Default Value
F4.27	Feedback disconnection detecting value	0.0~100.0%	0.0%
F4.28	Feedback disconnection detecting time	0.0~360.0s	1.0s

Feedback disconnected detecting value: this detecting value is relative to the full range (100%). The system detects the PID feedback value all the time. When the feedback value is less or equal to the feedback disconnected detecting value, the system starts to time the detection. When the detecting time exceeds the feedback disconnected detecting time, the system will send an alert of feedback disconnecting failure(E02E).

Function Code	Name	Setting Range	Default Value
F4.29	Multi-Speed 0	-100.0~100.0%	0.0%
F4.30	Multi-Speed 1	-100.0~100.0%	0.0%
F4.31	Multi-Speed 2	-100.0~100.0%	0.0%
F4.32	Multi-Speed 3	-100.0~100.0%	0.0%
F4.33	Multi-Speed 4	-100.0~100.0%	0.0%
F4.34	Multi-Speed 5	-100.0~100.0%	0.0%
F4.35	Multi-Speed 6	-100.0~100.0%	0.0%
F4.36	Multi-Speed 7	-100.0~100.0%	0.0%

Note: The multi-speed symbol defines the operation direction. If it is negative, the operation direction is reverse. Frequency setting 100.0% is corresponding to maximum frequency(F0.04).

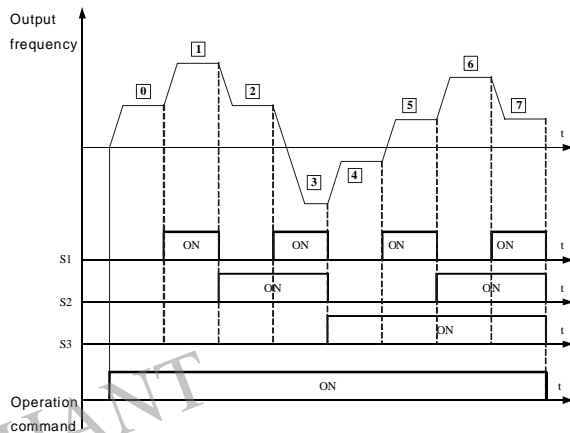

Fig.6-20 multi-speed logic Diagram

Relationship between multi-speed and S1、S2、S3terminals

S1	S2	S3	Current segment of multi-speed control
OFF	OFF	OFF	Multi-Speed 0
ON	OFF	OFF	Multi-Speed 1
OFF	ON	OFF	Multi-Speed 2
ON	ON	OFF	Multi-Speed 3
OFF	OFF	ON	Multi-Speed 4
ON	OFF	ON	Multi-Speed 5
OFF	ON	ON	Multi-Speed 6
ON	ON	ON	Multi-Speed 7

F5 Protection Parameters

Function Code	Name	Setting Range	Default Value
F5.00	Motor Overload Protection Option	0: No protection	1
		1: normal motor	
		2: Variable Frequency motor	

0: no protection. There is no motor overloading protection characteristic (caution to use),and thereby the inverter has no protection to the overloaded motor.

1: normal motor (with low speed compensation). As general motor has a poor heat emission at low speed, the relevant electronic thermal protection should be regulated properly.The low speed compensation characteristic here mentioned is to switch down the overloading protection threshold for the motor with an operation frequency lower than 30 Hz.

2: Variable frequency motor (without low speed compensation). As the heat emission of special variable frequency motor is not affected by speed, it is not required to regulate the protection value for low speed operation.

Function Code	Name	Setting Range	Default Value
F5.01	Motor Overload Protection Current	20.0%~120.0% (motor rated current)	100.0%

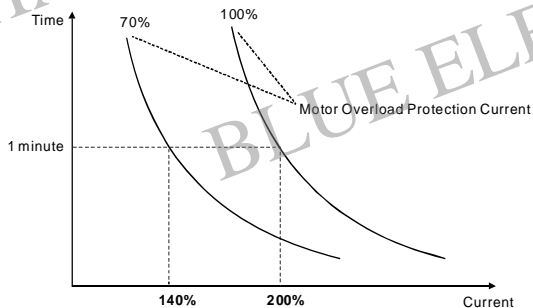

Fig.6-21 Motor Overload Protection Current

The value can be determined by following equation:

$$\text{Motor overload protection current} = (\text{maximum current/rated current}) \times 100\%$$

It is mainly applied to the cases that big inverter drives small motor, requiring to correctly set up this function to protect the motor.

Function Code	Name	Setting Range	Default Value
F5.02	Power-down Frequency Drop Point	70.0~110.0%(standard bus voltage)	80.0%
F5.03	Instant power-down Frequency drop rate	0.00Hz~99.99Hz	0.00Hz

If the instant power-down drop rate is set to 0, the instant power-down restart function is invalid.

Instant power-down frequency drop point: it is indicating when the bus voltage, after the power network is down and drops to the instant power-down frequency drop point, the inverter starts to decrease the operation frequency based on the instant power-down frequency drop rate, enabling the motor to generate electricity which is fed back to keep the bus voltage, and thus ensuring the inverter is operating normally till inverter power is on again.

**Important: Adjusting these two parameters properly can magnificently achieve the power network switching instead of causing inverter protection and thus causing production shutdown.**

Function Code	Name	Setting Range	Default Value
F5.04	Over-voltage Stall Protection	0: prohibit	0
		1: allow	
F5.05	Over-voltage Stall Protection Voltage	110~150%(380V)	120%
		110~150%(220V)	115%

During the inverter deceleration, the load inertia may cause the actual motor speed drop rate lower than the output frequency drop rate, and thereby the motor generates electricity and feeds it back to the inverter, causing the inverter bus voltage going up and even bus over-voltage breakdown which then can cause inverter tripping if no provision is made.

Over-voltage stall protection function is to detect the bus voltage and compare it with the stall over-voltage point defined by F5.05 (relative to the standard bus voltage). If it exceeds the over-voltage stall point, inverter output frequency stop going down, and when the next bus voltage detected is lower than the over-voltage stall point, the inverter continues to decelerate, as shown by following figure:

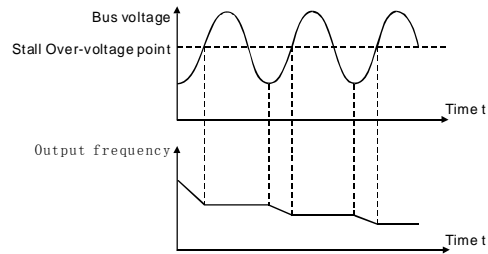

Fig.6-22 Over-voltage Stall Function

Function Code	Name	Setting Range	Default Value
F5.06	Over-current stall setting	80~200%	150%
F5.07	Over-current gain setting to avoid of stalling	0~100	20

When inverter is running, the actual climbing rate of motor speed is lower than climbing rate of output frequency because load is too big. If you don't take any action, it will cause over current fault in acceleration then inverter will trip.

Over-current stall protection function is to detect output current and compare it with the current limit defined by F5.06. If it exceeds the current limit, output frequency drop down according to F5.07. When it show that output current is lower than limit current, inverter will remain normal operation.

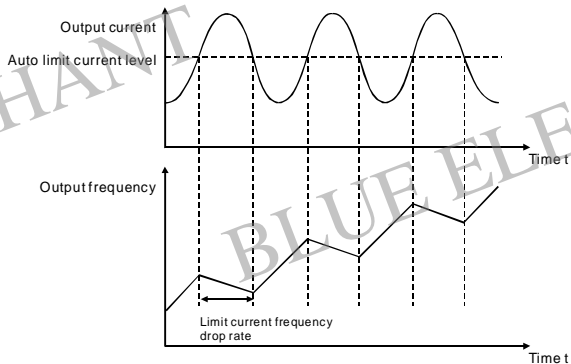

Fig. 6-23 Limit current protection

**F6 Communication Parameters**

Function Code	Name	Setting Range	Default Value
F6.00	Communication Address	1~247,0 is the broadcast address	1

When master machine plan to transmit a frame, slave communication address is set to be 0, it is also broadcast address. All slave machine in MODBUS will receive this frame but not response.

**Note: slave address is not allowed to set 0.**

Local communication address is unique for every slave machine within communication network. This is basis of utilization of point to point communication between master machine and inverter.

Function Code	Name	Setting Range	Default Value
F6.01	Baud rate setting	0: 1200BPS	3
		1: 2400BPS	
		2: 4800BPS	
		3: 9600BPS	
		4: 19200BPS	
		5: 38400BPS	

This parameter is used to set transmission rate.

Function Code	Name	Setting Range	Default Value
F6.02	Data pattern	0:No check (N,8,1) for RTU	0
		1:Odd check (E,8,1) for RTU	
		2:Even check (O,8,1) for RTU	
		3:No check (N,8,2) for RTU	
		4:Odd check (E,8,2) for RTU	
		5:Even check (O,8,2) for RTU	
		6:No check (N,7,1) for ASCII	
		7:Odd check (E,7,1) for ASCII	
		8:Even check (O,7,1) for ASCII	
		9:No check (N,7,2) for ASCII	
		10:Odd check (E,7,2) for ASCII	
		11:Even check (O,7,2) for ASCII	
		12:No check (N,8,1) for ASCII	
		13:Odd check (E,8, 1) for ASCII	
		14:Even check (O,8,1) for ASCII	
		15:No check (N,8,2) for ASCII	
		16:Odd check (E,8,2) for ASCII	
17:Even check (O,8,2) for ASCII			

The data pattern set by inverter must be the same as data pattern set by master machine. Otherwise, communication can not accomplish.

11-bits (for RTU)

DATA Frame: 8-N-2

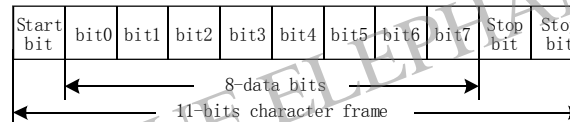

DATA Frame: 8-E-1

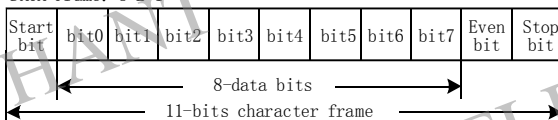

DATA Frame: 8-0-1

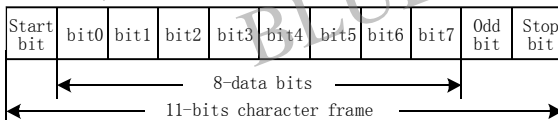

10-bits(for ASCII)

DATA Frame: 7-N-2

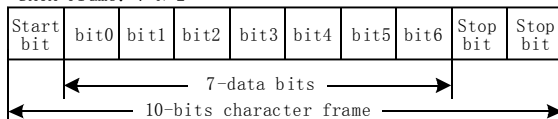

DATA Frame: 7-E-1

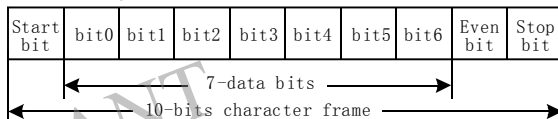

DATA Frame: 7-0-1

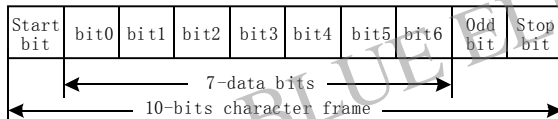

Function Code	Name	Setting Range	Default Value
F6.03	Communication response delay	0~200ms	5ms

Response delay: means the interval time from the end of data receive to transmitting response data to upper level machine. If response delay time is smaller than system operation time, response delay time should be system operation time. If response' delay time is longer than system operation time, inverter can not transmit data to upper level machine until response delay time reached.

Function Code	Name	Setting Range	Default Value
F6.04	Communication overtime fault time	0.0 (invalid) , 0.1~100.0s	0.0s

When this parameter is set to be 0.0s, this function is invalid.

When this function is valid, if the interval time between two communications exceeds communication overtime time, it will cause communication fault (E018).

Function Code	Name	Setting Range	Default Value
F6.05	Communication error measure	0: Alarm and free run stop	1
		1: No alarm and keep running	
		2: No alarm and stop according to stop mode (by communication)	
		3: No alarm and stop according to stop mode (by all control mode)	

Function Code	Name	Setting Range	Default Value
F6.06	Response measure	0: Response when write	0
		1: No response when write	

When this parameter is set to be 0, Response when write.

When this parameter is set to be 1, No Response when write. This function can improve communication speed.

## Chapter 7 Fault Diagnosis and Countermeasures

DZB200 has 25 pieces of alarm information and protection functions in total. Once the fault occurs, the protection function starts, the inverter stops inputting, the fault relay contact point is activated, and the fault code will be displayed on the display panel of the inverter. Before seeking services, the subscriber may conduct the self-check according to the prompt given in this section, analyze the fault causes, and find out the solutions. If the fault belongs to the causes described in the broken line box, please seek the service by contacting the inverter agent or directly contacting our corporation.

### Common Faults and the Fault Diagnosis

The following faults may probably occur during the using of the inverter, please refer to the methods described below to perform the fault analysis.

#### 1. No Electricity Display

- 1) Check with multimeter if the input power supply of the inverter is consistent with its rated voltage. If there is something wrong with the power supply, please check and remove it.
- 2) Check if the three-phase rectifying bridge is intact. If the rectifying bridge has been exploded, please seek technical service.
- 3) Check if the CHARGE indicator is on. If the indicator is off, the fault will be on the rectifying bridge or the buffering resistance. If the indicator is on, then the fault may probably lies in the switch on/off part, please seek for help.

#### 2. The air Switch Trips off After Power-on

- 1) Check if the earthing or short circuit occurs between the input power supplies and remove the problem.
- 2) Check if the rectifying bridge has been broken down. If so, seek for the service.

#### 3. The Motor Does not Run After the Inverter Starts to Run

- 1) Check if there is equalizing three-phase input between U, V and W. If yes, the motor circuit or itself may be damaged, or the motor stops turning for mechanical reason. Please remove it.
- 2) If there is input but the three phases are not equalizing, the inverter drive board or the output module may be damaged. Please seek for the service.
- 3) If there is no output voltage, the drive board or output module may be damaged. Please seek for the service.

#### 4. When the Power-on Inverter Displays Normally, the Air Switch Trips off After the Operation.

- 1) Check if the short circuit occurs between the output modules. If yes, please seek the service.
- 2) Check if the short circuit or earthing occurs between the motor lead wires. If yes, please remove it.
- 3) If the tripping occurs only occasionally and the distance between the motor and the inverter is big, then the adding of an output AC reactor shall be considered.

### 1. Under voltage of DC Bus(E001)

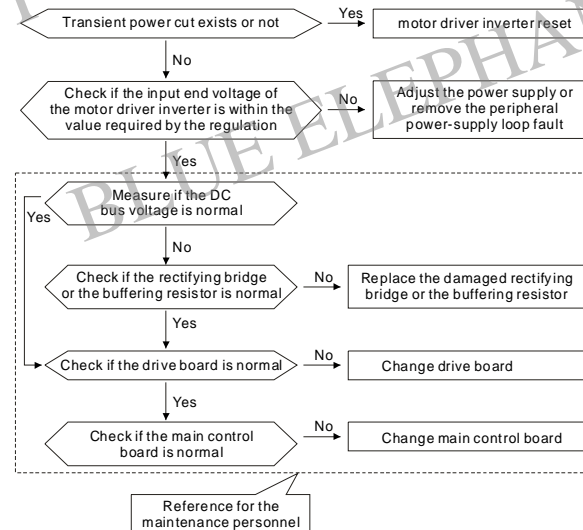

### 2. Over voltage during acceleration(E002)

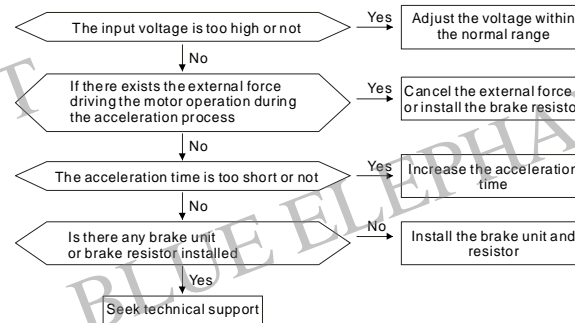

3. Over voltage during running(E003)

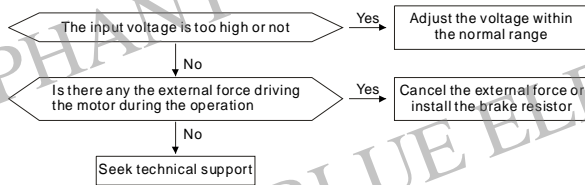

4. Over current during acceleration(E004)

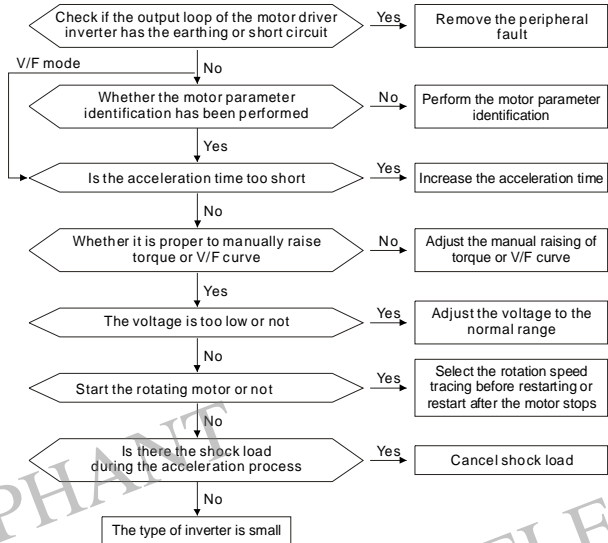

5. Over current during deceleration(E005)

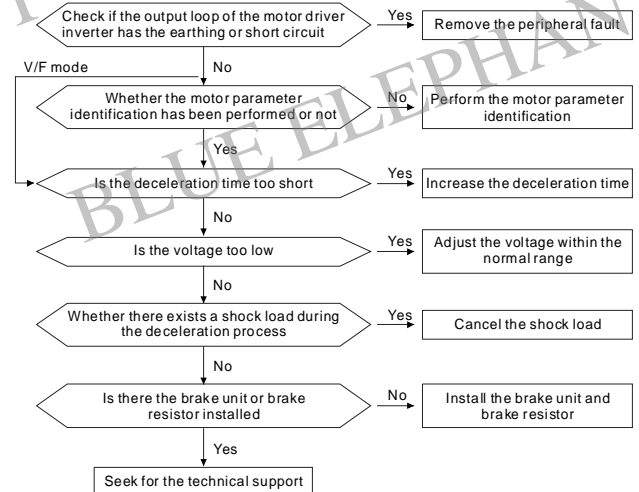

6. Over current during running(E006)

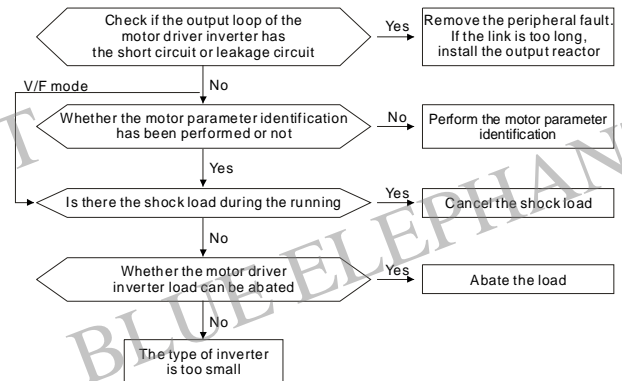



7. Motor Over Load(E007)

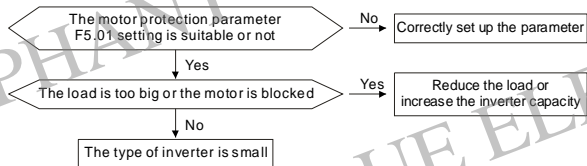

8. Inverter Over Load(E008)

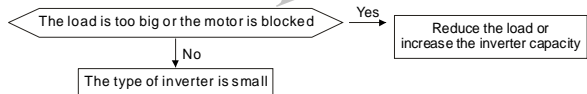

9. Inverse unit protection(E009, E019, E029)

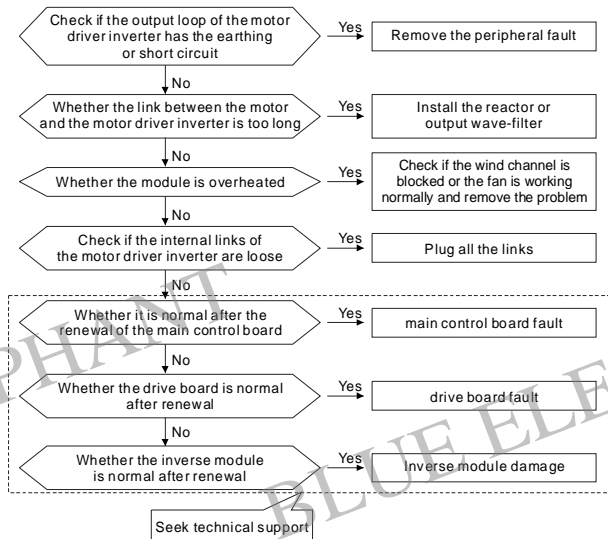

10. Over voltage during deceleration(E00A)

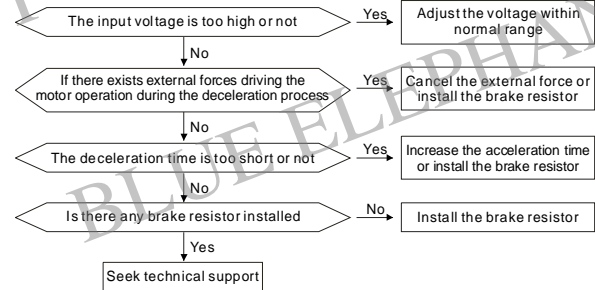

11. External Failure(E00D)

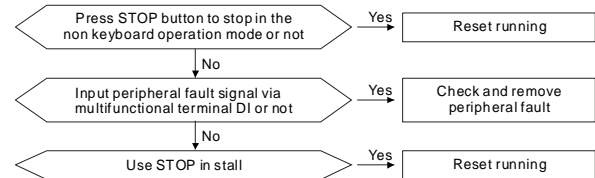

12. Diode Module Over Heat(E00E)

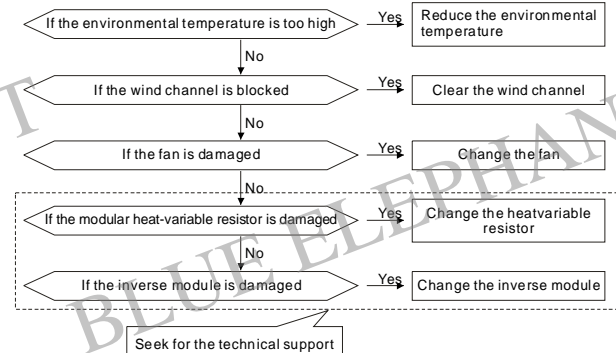

13. EEPROM read-write failure(E00F)

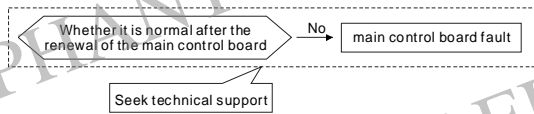

14. Input phase failure(E012)

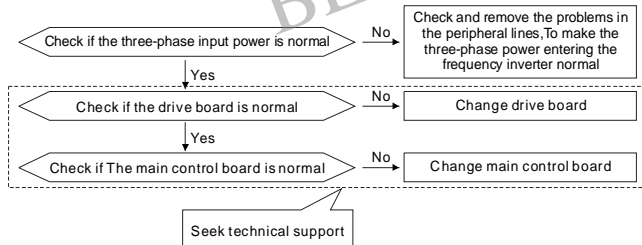

15. Output phase failure(E013)

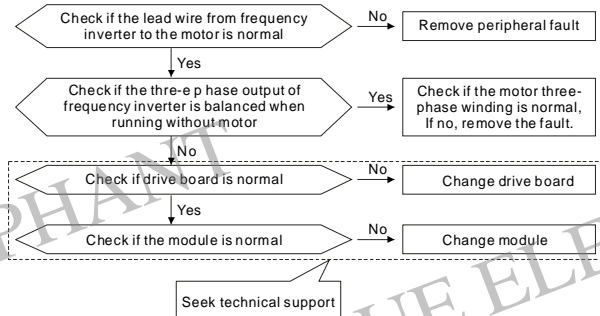

16. Current Inspection Circuit Failure(E015)

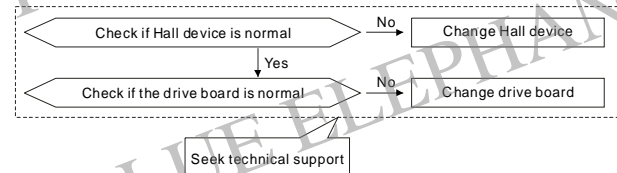

17. Motor self-learning failure(E016)

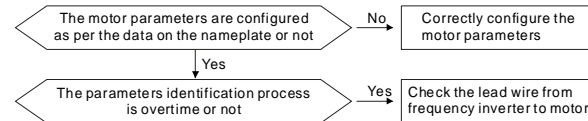

18. Communication Failure(E018)

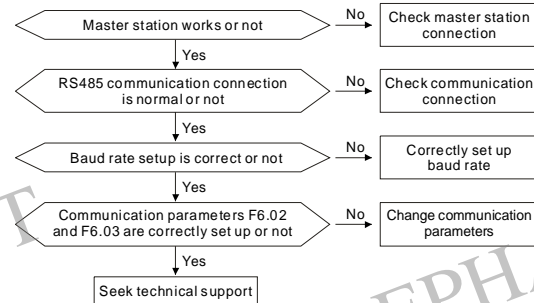

## Chapter 8 Quality Guarantee

Quality guarantees of our products is transacted as the following rules and regulations:

### 8.1 Responsibility of manufacturer:

A: Interior

- ★ One month goods exchanging ,maintenance, and return after delivery
- ★ Three months goods exchanging ,maintenance after delivery
- ★ Twelve months goods maintenance after delivery

B:Abroad

- ★ Three months goods maintenance after delivery

### 8.2 Whenever and wherever use our product, users have the rights to take our service with payment.

All distributors, manufacturers and agents in the whole country can provide the service.  
Our company has the right to entrust maintenance to others.

### 8.3 Responsibility immunity:

- ★ Abuse producing or inducing failure is out of our responsibility
- ★ The damage or referred,secondary damage caused by the fault of the equipment will not be compensated.

### 8.4 The equipment is guaranteed for twelve months from the date of exporting.

### 8.5 However the remedy of faults caused by the following reasons will be at user's cost, even though it happens during the guarantee period.

- ★ Improper operation, unauthorized repair or modification;
- ★ Operation beyond the standard specifications;
- ★ Falling down , barbarous transport;
- ★ Device ageing and failure caused by unsuitable environment;
- ★ Damage caused by earthquake, fire, windstorm, flood, lightning ,abnormal voltage and other natural disaster, or effect hereof.

## Appendix A: Standard Specifications

### 1.1 Technical Specification

Series		DZB200
Item		Specification
Input	Rated Voltage	1AC220V±15%, 3AC220V±15%, 3AC380V±15%
	Frequency Range	47-63Hz
Output	Output Voltage	Proportional to Input Voltage
	Output Frequency	0-600Hz
Control Characteristics	Control mode	V/F control
	V/F curve	2 modes: Line, square v/f curve
	Command channel	operation panel, control terminal, serial port
	Frequency source	digital frequency reference, analog voltage reference, analog current reference, pulse reference, communication ports reference. These frequency sources can be selected through different methods.
	Overload Capacity	B:150% rated current 60 seconds; 180% rated current 10 seconds; P:120% rated current 60 seconds; 150% rated current 10 seconds
	Start torque	1.5Hz/150%(V/F)
	Speed control range	1:100(V/F)
	Speed accuracy	±0.5%
	Carrier frequency	1.0-15.0KHz
	frequency resolution	Digital setting: 0.01Hz Analog setting: Maximum frequency×0.1%
	Torque boost	0-10.0%
	Accel/decel Mode	Two accel/decel curve,range:0.1-360sec
	DC brake	Start DC break,Stop DC break
	Jog control	Jog frequency range: 0.00Hz-Maximum output frequency; Jog Acc/Dec time:0.0-360.0s
Multi-Speed Function	Internal PLC operation;8-speed Control	
Internal PID	Realize product-line automatic control system	
Automatic Voltage Adjustment Function	Keep static output voltage automatically when mains voltage fluctuating.	
Shared DC bus	Several motors can share one DC bus.	
Input/output characteristic	Input terminal	Eight digital input terminals and one of them can input high speed pulse. Two analog input terminals, one can be inputted voltage and the other can be inputted voltage or current.
	Output terminal	One digital output terminal(Two for 7.5kw below) Two relay output terminal(One for 7.5kw below) One analog output terminal

Series		DZB200
Item		Specification
Display	LCD Display	pre-set frequency;operate frequency;output current;motor speed;input voltage; output voltage;input/output terminals status;fault information,etc
	LED Status indication	Operation/Stop,FWD/REV,Function indication,etc
	External meter display	Output frequency,Output current (0~10VDC)
	Protection function	input/output phase failure protection, Over current protection;Over voltage protection;Under voltage protection; Over heat protection; overload protection,etc
Environment	Applicable Situation	Indoor in which there is no direct sunlight, dust, erosive gas,combustible gas, oil smoke, water vapor, dripping, salt, etc.
	Altitude	Lower than 1,000 meters
	Ambient temperature	-10℃~+40℃
	Humidity	20%~90%RH, without condensation

**1.2 AC220VSeries Rating:**

Voltage classification AC220V	0005	0007	0015	0022	0037	0005	0007	0015	0022	0037	0055	0075	0110	0150	
motor rating(KW)	0.5	0.75	1.5	2.2	3.7	0.5	0.75	1.5	2.2	3.7	5.5	7.5	11	15	
Inverter output(KVA)	0.7	1.0	2.0	3.0	5.0	0.7	1.0	2.0	3.0	5.0	7.5	10	15	20	
Output current(A)	2.5	4.0	7.0	10	17	2.5	4.0	7.0	10	17	25	34	50	68	
Output voltage(V)	Adjustable from 0 to input voltage														
Input Rating	Input current(A)	4.0	5.2	10	15	25	3.0	5.0	7.7	11	18	26	35	51	69
	Input voltage/frequency	Single 220V, 50/60Hz			3 phase 220V, 50/60Hz										
	Operational range (V)	± 15%													
	Operational range (Hz)	47~63Hz													

**Appendix B Dimensions**

• Dimensions and Applicable Moter

Model	AC Drive Model	Applicable Moter(KW)	Dimensions (mm)					
			A	B	H	W	D	d
FL08	DZB200M0005L2	0.55	85	131	142	75	113	5
	DZB200M0007L2	0.75						
FL22	DZB200M0015L2	1.5	100	141	151	89	117	5
	DZB200M0022L2	2.2						
	DZB200M0007L4	0.75						
	DZB200M0015L4	1.5						
FL26	DZB200M0022L4	2.2	104	138	149	94	130	5
	DZB200J0005L2	0.55						
	DZB200J0007L2	0.75						
	DZB200J0015L2	1.5						

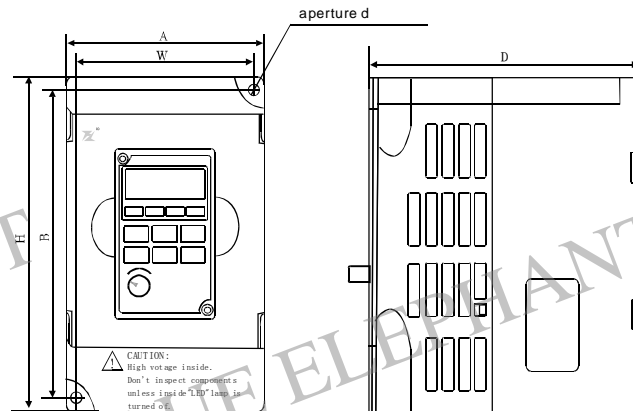

Product each parts of names

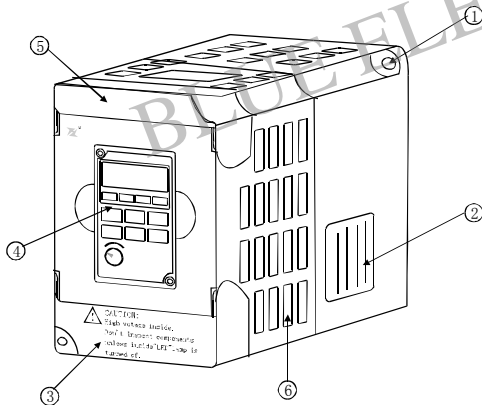

- ①: Aperture bolt bore
- ②: Inverter nameplate
- ③: Lower cover of inverter output
- ④: Digital operate keys
- ⑤: Up cover of power input
- ⑥: Spread heat export
- ⑦: Power input terminals
- ⑧: Control circuit terminals of main control board
- ⑨: Braking resistor wiring terminal
- ⑩: Inverter output terminals
- ⑪: Grounding terminal

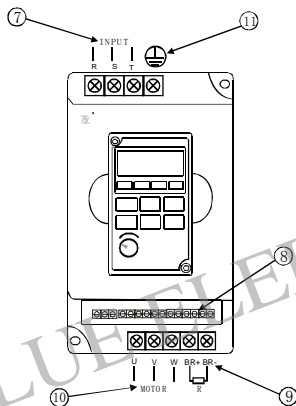

### Appendix C Accessories List

1. All Braking Resistors & Braking Units Use in AC drives

Voltage	KW (HP)	Braking Unit		Braking Resistors Model No. of Units Used			Braking Torque 10%ED
		Model 70BR	Number	Resistors Values Recommended	Resistors Model	Number	
220V (1PH)	0.5(0.7)	Built in		80W 200Ω	80W 120Ω	1	100%
	0.75(1.0)	Built in		80W 200Ω	80W 120Ω	1	
	1.5(2.0)	Built in		150W 100Ω	150W 100Ω	1	
	2.2(3.0)	Built in		200W 80Ω	200W 68Ω	1	
380V (3PH)	0.75(1.0)	Built in		80W 400Ω	80W 400Ω	1	
	1.5(2.0)	Built in		120W 330Ω	180W 300Ω	1	
	2.2(3.0)	Built in		160W 250Ω	250W 250Ω	1	

Note:

1. Please only use the resistors and recommended valves.
2. Take into consideration the safety of the environment when installing the braking resistors.
3. If the minimum resistance value is to be utilized, consult local dealers for the calculation of the Watt figures.

2. Standard Extension Cable

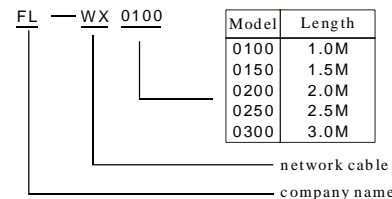



## A card of user's protect to fix card

<b>Model:</b>	Invoice number:
<b>Number:</b>	Buy date of machine :
Manufacturer:	
Tel:	
User:	
Tel:	
Address:	
Post code:	
Maintain Date:	
Detailed record:	

**Note:**User writes the card and mails it to the manufacturer during ten days.

## B card for user's file

Model:	Invoice number:
Number:	Buy data of machine:

Honorific customer:

Welcome to use FuLing Inverter!

1、 You have the" three guarantees" from the time that you buy the machine.Because of the quality of the products,you have the services as follows:

- 1)Return the machine in one month.
- 2)Replacement the machine in three months.
- 3)Cost-free sevice in twelve months.

Outside of 12 months,our company will take normal material expenses.

2、 When you buy the manchine,please file the B card and mails the A cardback during ten days,or our company only service for costing

- 3、 Please note the product's number and invoice number when maintain the machine.
- 4、 Because of the natural and artificial factor or discorrect dismantleto fix or wrong use to be broken down,our company only service for costing.